

A Microscope that Measures Up to Individual Needs

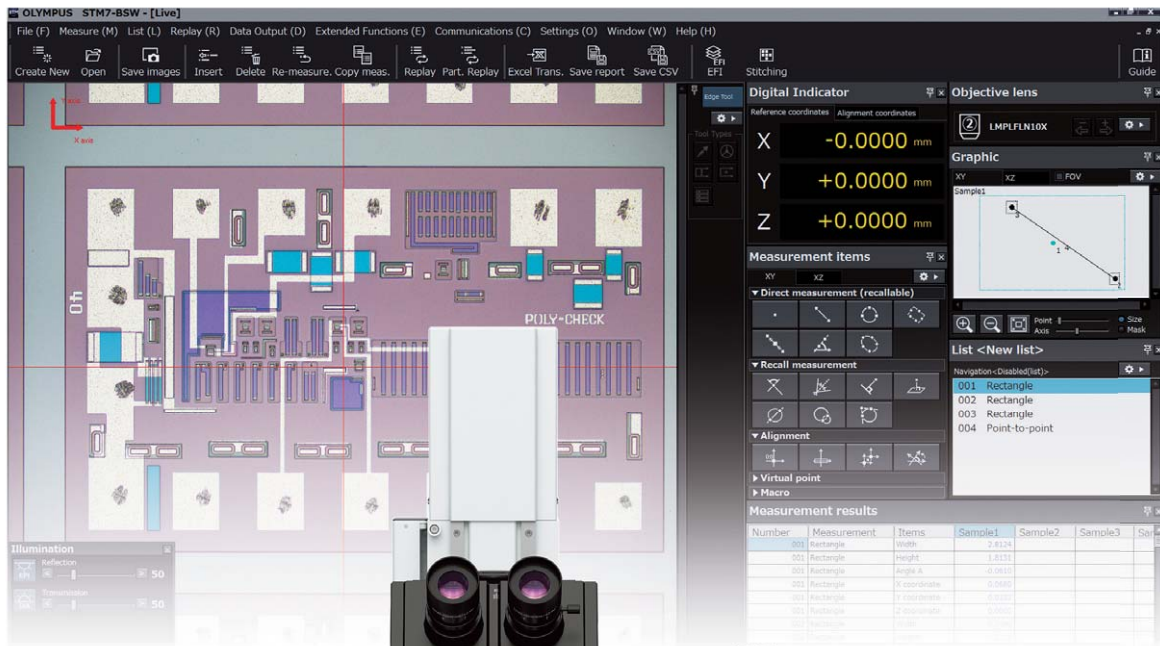

The Highly Reliable STM7 Measuring Microscope— Backed by a Century of Olympus Technology

The new STM7 measuring microscope series offers dependable quality from generations of Olympus' technology, and experience gained through more than a century of microscope development with more than 50 years of measuring microscope experience.

- Vivid imaging of extremely minute samples enabled by outstanding optical technology.
- Accurate sample measurement delivered through advanced measuring technology.
- Simpler and more accurate measurements realized with autofocus and focus navigator.
- Reliable and dependable measurements provided by a comprehensive traceability system.

For all these reasons and more, Olympus' measuring microscopes have continued to be chosen over the years.



STM7

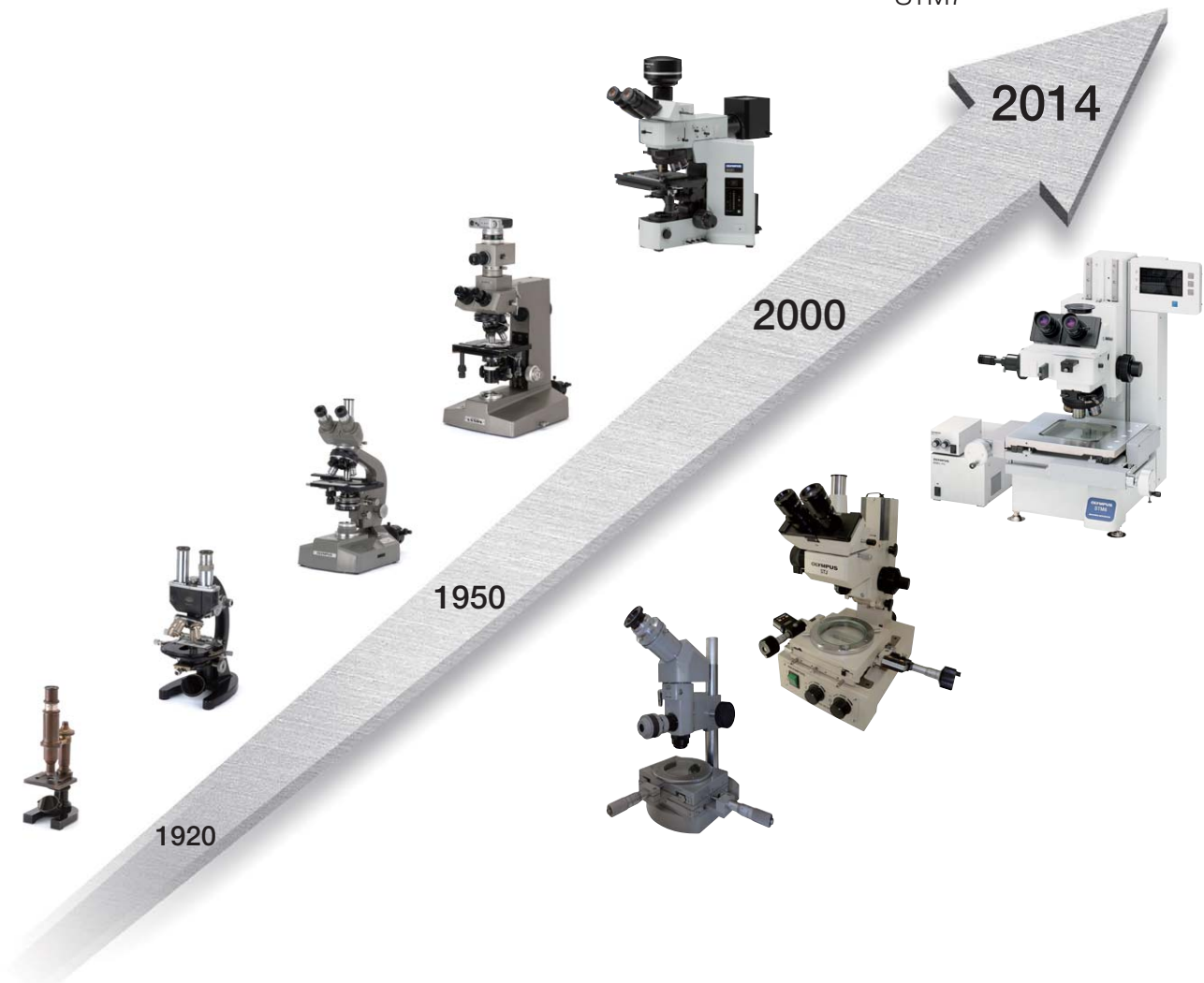

Accurate Measurements through the Integration of an Optical Microscope and Advanced Measurement Capability

Observation Performance Refined through Years of Microscope Development

The STM7 series uses the same UIS2 infinity-corrected optical system used in state-of-the-art optical microscopes. As a result, observed images have high resolution and high contrast, with aberration thoroughly eliminated to help ensure highly accurate measurement in minute detail.

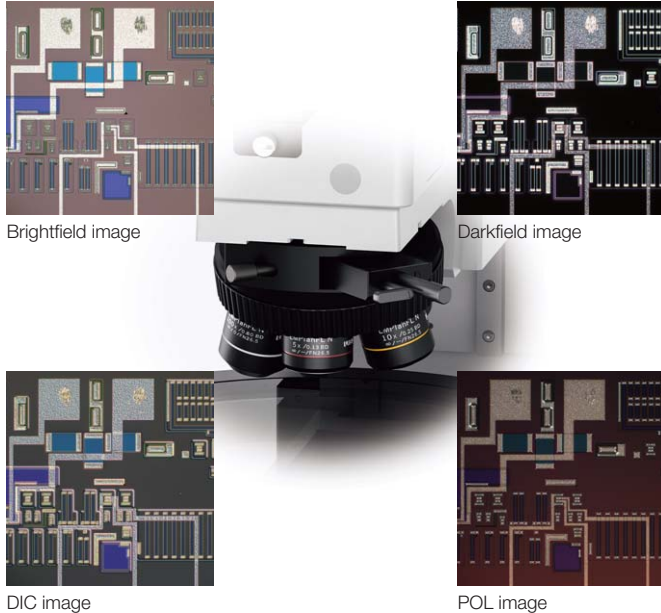

Measurement Reliability Enhanced with a Stage-Mounting Plate Crafted from Stone

To provide further assurance of measurement accuracy, the STM7 series uses a highly durable, vibration-resistant frame with a granite surface plate. As a result of this stability, measurements can be taken at sub-micron-levels while ensuring minimal error.

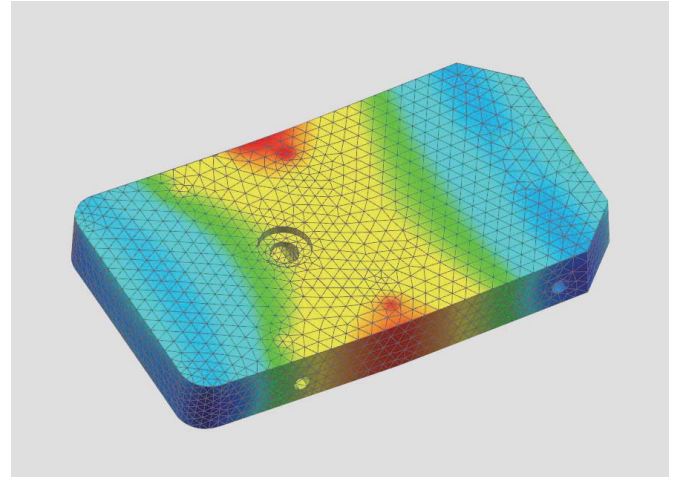

STM7-LF FEM analysis

Continuing to Provide User-friendly, High-Precision, 3-axis Measurement as a Pioneer of Height Measurement

As modern manufacturing technology becomes increasingly miniaturized and precise, highly accurate measurements are even more essential—not only along the horizontal XY axes, but also along the Z-axis. Olympus has responded to such needs by being the first to realize an autofocus system for measuring microscopes by means of the reflective active, confocal method.

Reflective Active, Confocal Autofocus System Optical Path

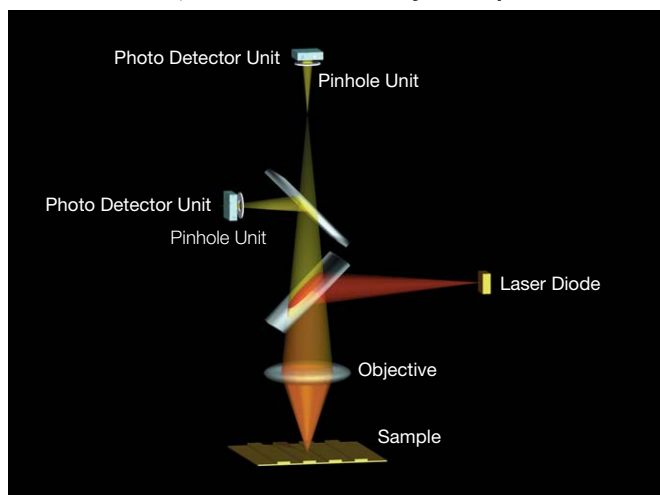

Dependable Quality Based On a Strict Traceability System*

The accuracy of Olympus' measuring microscopes is controlled by a strict traceability system and Olympus even offers traceable calibration at the time of installation.



* Calibration certificate issued by Olympus Corporation Test & Analysis Center, and authenticated by ILAC-MRA calibration accreditation agencies (JCSS, JAB).

* Traceability systems vary depending on periods and countries/regions. The samples used in STM7 calibrations are calibrated in each country/region. Please ask Olympus for details.

The Measuring Microscope Engineered to Fit Your Needs

Whether samples are small or large, simple or complex, or measurements are being taken by a novice or an expert, the Olympus STM7 range features measuring microscopes tailored to fit your needs.



■ Wide Coverage

Compatible with a range of measurement and observation needs

■ Operability

Simpler, more efficient operation

■ Height Measurement

Highly accurate measurement of samples with irregular surfaces

■ Measurement Support System

Enables simple, highly accurate measurements of complex forms

Stage Selection (in mm)

50 x 50, 100 x 100,
200 x 200, 300 x 300

Optics

Measuring Objectives/
Metallurgical Objectives

STM7 Series

Frame

Manual Focus/
Motorized Focus

Focusing Equipment

Manual Focus Navigator Unit/
Autofocus Unit

Olympus Measurement
Software

STM7 Lineups

3-Axis Measurements with a 0.1- μm Readout in Every Model

Manual Z-axis Focusing Models



STM7-SF
Equipped with
50 mm x 50 mm stage or
100 mm x 100 mm stage



STM7-MF
Equipped with
200 mm x 200 mm stage



STM7-LF
Equipped with
300 mm x 300 mm stage

Motorized Z-axis Focusing Models



STM7-SFA
Equipped with
50 mm x 50 mm stage or
100 mm x 100 mm stage



STM7-MFA
Equipped with
200 mm x 200 mm stage



STM7-LFA
Equipped with
300 mm x 300 mm stage

Wide Coverage: Stage

Offering Stages to Fit the Sample Size at Hand, while the Square Stroke Acts to Resolve Inconvenient Measurement-Related Issues



Common Problems

Short measurement stroke precludes the measurement of larger samples.

Sample rotation required to compensate for shorter Y than X-axis coverage during measurement is time inefficient. Until now, large stages have offered a sufficient measurement coverage on the X-axis, but only less coverage on the Y-axis.

Due to the narrow measurement range, it is impossible to line up large numbers of samples on the stage for measurement at once.



STM7 Solutions

The STM7 features a 300 mm x 300 mm stage capable of measuring large samples, including 300 mm wafers and printed circuit boards.

X and Y-axis measurement areas are long and of equal length, eliminating the need to rotate samples.

Long measurement areas for both the X and Y-axis allow multiple samples to be lined up on the stage for more efficient measurement.

Maximum Measurement Stroke 300 mm x 300 mm

Four types of stages are available, each with a unique square measurement stroke (choose from 50 mm x 50 mm, 100 mm x 100 mm, 200 mm x 200 mm, and 300 mm x 300 mm). From small to large size samples, there is a stage that fits the sample being measured.



STM7-CS50
50 mm x 50 mm

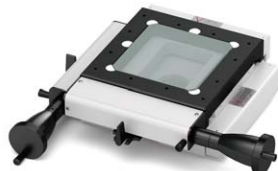

STM7-CS100
100 mm x 100 mm

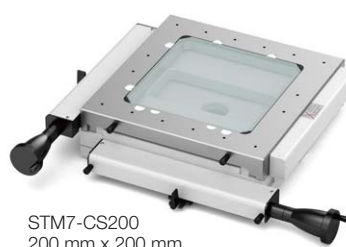

STM7-CS200
200 mm x 200 mm

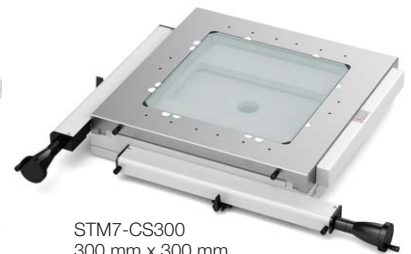

STM7-CS300
300 mm x 300 mm

The Square Stroke Resolves Inconvenience during Measurement Operation

The 300 mm square length stage enables the same measurement stroke to apply to both the X and Y-axes, which means it can be used to measure large samples, such as 300 mm wafers and printed circuit boards without changing their orientation.

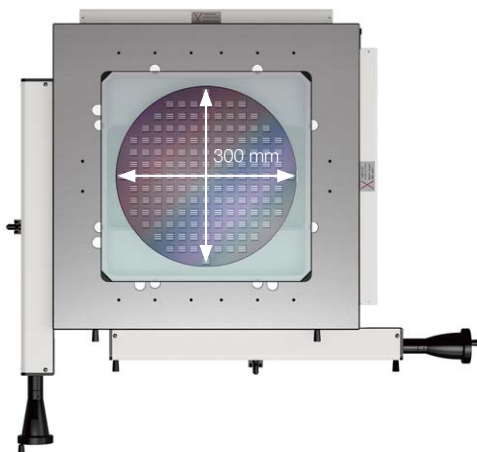

Clutch Control Enables Rapid Switching between Coarse and Fine Movements

A clutch system enables rapid switching between coarse and fine movements. Thanks to this switching function, the stage can also be moved rapidly along the X- and Y-axes, and freely across the XY plane.



X-line clutch

Wide Coverage: Optics

Extend the possibilities of Observations With the Unique Adapter that Broadens the Range of Magnifications for Observation and the Range of Working Distances



Common Problems

Most conventional measuring microscopes only accept a measuring objective or metallurgical objective, and so are unable to meet the requirements for a wide variety of observations.



STM7 Solutions

The STM7 meets the requirements of a wide variety of observations. It responds to your needs at both low and high magnifications, enables the measurement of uneven samples requiring ultra-long working distance objectives, and even offers a variety of observation methods.

Use the Same Microscope for Both Low- and High-Magnification Observations

The STM7 accepts both a metallurgical objective and a measuring objective by exchanging a revolving nosepiece with a measuring objective adapter. This means that the STM7 combines both metallurgical optics and measuring optics in one microscope. In this way, the STM7 series satisfies a range of needs, no matter whether measuring a wide area or tiny region, measuring the size of differences between levels, or assisting the user in deciding on the best observation method to choose.

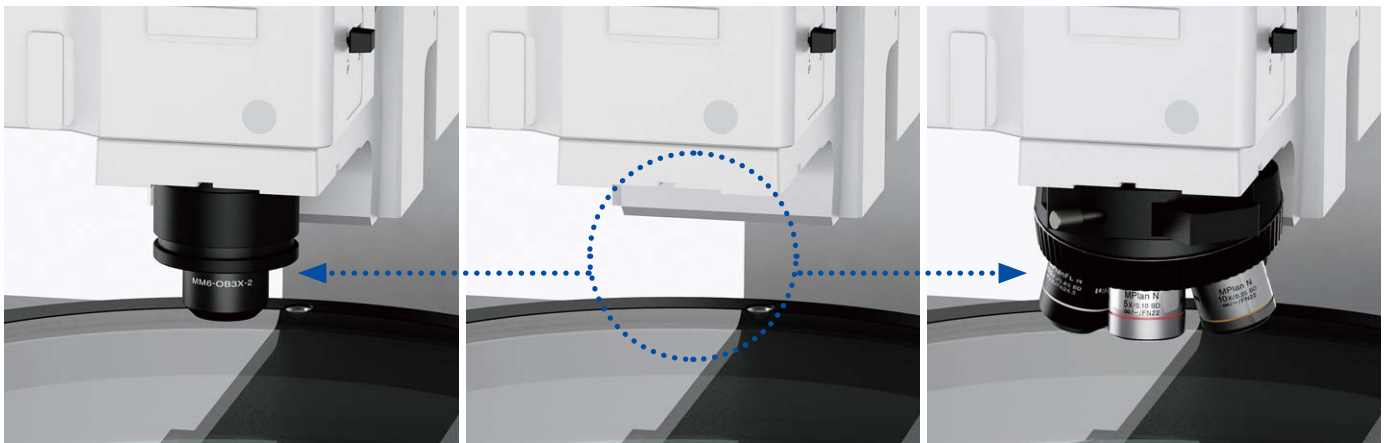

Measuring Objectives

Because the measuring objectives have an extremely long working distance, they provide confidence when focusing on samples with large peaks and troughs while reducing worries of the objective coming into contact with the sample. Furthermore, their low-magnification capability enables wide areas to be observed in a single view.

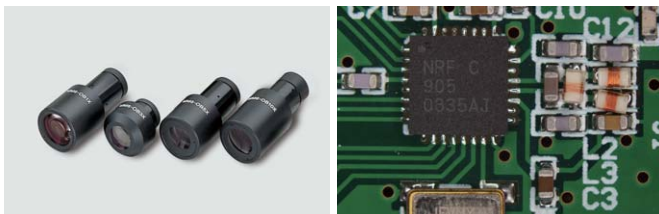

Brightfield image

Metallurgical Objectives

Metallurgical objectives enable high-magnification, high-resolution observation capability comparable to that of optical microscopes. What's more, these objectives can be used not only for brightfield, but also for darkfield and DIC observation.

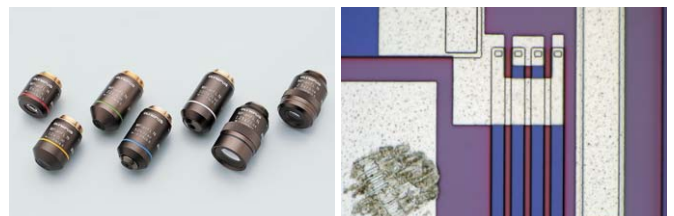

Brightfield image

STM7-MMOBAD: Measuring Objective Mount Adapter

Use of the STM7 measuring objective mount adapter measuring objective adapter enables a measuring objective to be used even in a metallurgical objective optical system.

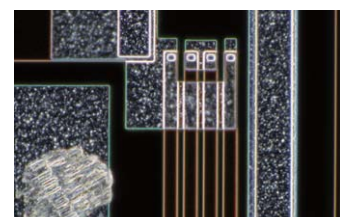

Darkfield image

Manual and Motorized Focusing Model Options

The STM7 Line Includes both Manual and Motorized Focus Options

Focus control is available with either manual or motorized operation. Choose the model that addresses your needs in terms of samples and measurement content, regardless of stage size—with all frames incorporating a linear scale for the Z-axis that enables 3-axis measurement.



Manual Z-axis Focus Models

Manual Z-axis focus models offer excellent cost performance—with familiar handle operation for rapid vertical movement that offers convenience for users who needs to measure samples with variety of heights.



Motorized Z-axis Focus Models

Operability is improved and handling fatigue is reduced for focus and height measurements when using the motorized focus unit. The coaxial knobs for coarse and fine movement offer a feeling similar to manual operation, while the models can also be equipped with an autofocus unit.

A Revolutionary Control Unit Refines Measuring Microscope Usability



Common Problems

Additional functions require additional operational units. Operators can't always locate the corresponding unit quickly, which significantly reduces measurement efficiency.

Numerous operational units and their power supplies around the main unit occupy valuable working space.



STM7 Solutions

Almost all measuring microscope operations can be efficiently completed on the nearest operational unit.

The system requires only a single operational unit and power supply, regardless of how many functions are added, freeing up workspace.

Controllers

With the STM7 series, a single controller makes it possible to perform virtually all measuring microscope operations, including use of readout reset, illumination control, focusing, and autofocus. For efficiency and convenience, the unit can be placed wherever you wish and operated easily with one hand.

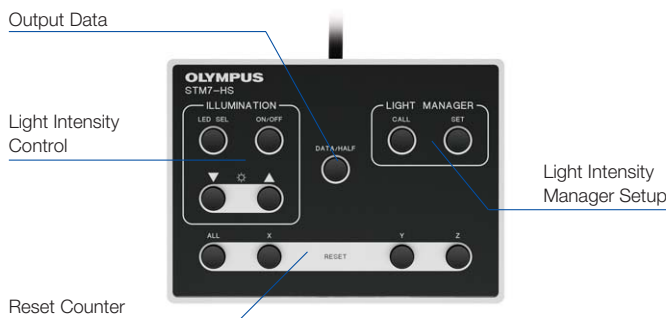

For Manual Z-axis Focusing Models:
STM7-HS Hand Switch



For Motorized Z-axis Focusing Models:
STM7-MCZ Focus Controller

Control Box

The power supply and transmission for each unit are combined in a single control box. This preserves maximal workspace even when a range of optional functions, such as the focus navigator, are added.

Automatic Light Intensity Adjustment Greatly Improves the Efficiency of Observation and Measurement



Common Problems

Analog volume adjustment used by conventional measuring microscopes does not enable the quantitative assessment of light intensity, which can lead to variability in measured values as light intensity changes.

With conventional measuring microscopes, light intensity may need to be adjusted every time the objective is switched—making for an inefficient workflow.



STM7 Solutions

Observations and measurements can always be performed under the same conditions thanks to the STM7's quantitative display of light intensity value.

Illumination method and light intensity are automatically adjusted to the preset value when the objective is switched, whenever the light intensity manager is used in combination with a coded revolving nosepiece.

Close Control through a Quantitative Digital Display of Light Intensity Values

The STM7 series provides a quantitative digital display of light intensity—enabling observations to always be made under consistent illumination conditions.



Digital display shows quantitative light intensity

Light Intensity Manager Eliminates the Need for Manual Adjustment

Light intensity manager can be used with the coded revolving nosepiece configuration. The coded revolving nosepiece automatically detects the switching of objectives. This allows the illumination method and light intensity to be registered for each objective, and adjusted automatically during measurements when the objective is switched. Now there is no need to manually adjust light intensity, which used to be required with every switch between magnifications.

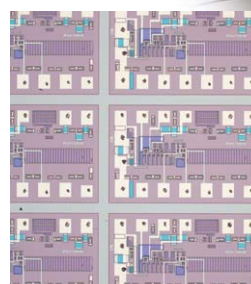

5X
Intensity 50

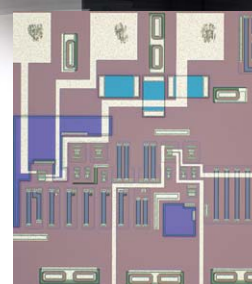

20X
Intensity 70

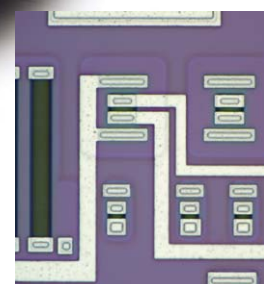

100X
Intensity 120

Operability: Digital Read Out

A Detachable Digital Read Out for Preferred Location Enables Swift, Convenient Checking of Measurement Results and Equipment Status



Common Problems

The need to check the operation status of equipment, such as illumination, or measured values on individual units makes overall operation cumbersome.



STM7 Solutions

The STM7 series displays microscope status, such as illumination, together with measured values on an indicator display area, for easy checking at a glance.

Digital Indicator Enables the Current Operation Status to be Verified Visually

The indicator displays the device status and settings. The minimum X, Y, and Z-axis values can be switched between 0.1 μm and 1 μm , and the display units can be switched between mm, μm , inches and mil.

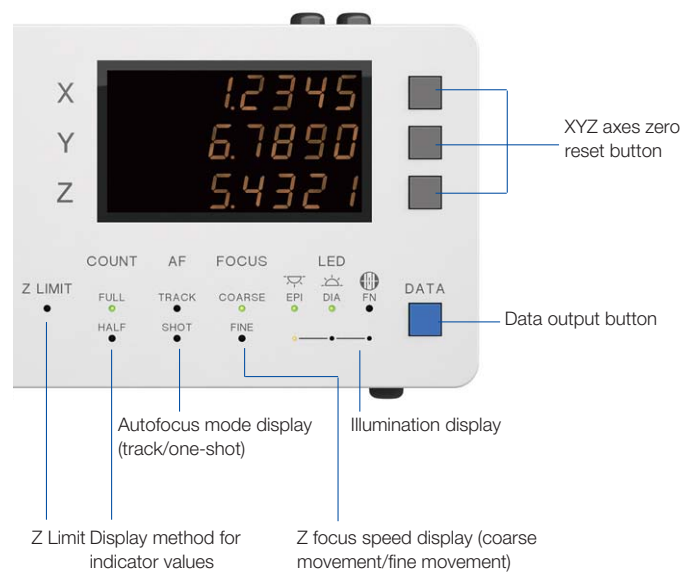

Detachable Digital Readout Allows for Individual Preference and Placement

Whether attached to the frame or a desk, the placement of the detachable digital readout is up to the individual user. While standing to take measurements, it can be placed on the side of the frame at almost the same height as the site of observation for an exceptional and easy view. When operating from a sitting position, such as observation or measurements on a monitor via a digital camera or when using the motorized Z-axis focusing model, simply place the digital readout and hand controller on the desk.



Digital readout attached to the frame



Digital readout placed on a desk

Achieve Faster, Simpler, More Accurate Height Measurement



Common Problems

When doing visual measurement, variations can arise in the height measurements between different operators. Furthermore, this measurement method is time-consuming and inefficient.



STM7 Solutions

The STM7 focus navigation system reduces the operator subjectivity in height measurements. It also shortens the time required to perform height measurement to achieve greater efficiency.

Simple and Highly-Precise Focusing System with Superior Repeatability

The Olympus' focus navigator delivers highly reproducible height measurement by projecting a pattern within the field of view and identifying vertical deviations. Slight errors can occur in height measurements taken with normal visual observation, even when focus appears to be sharp. The focus navigator, however, enables measurements to be made simply by matching up the marks—thereby reducing operator subjectivity in measurement results.

Visual Height Measurement

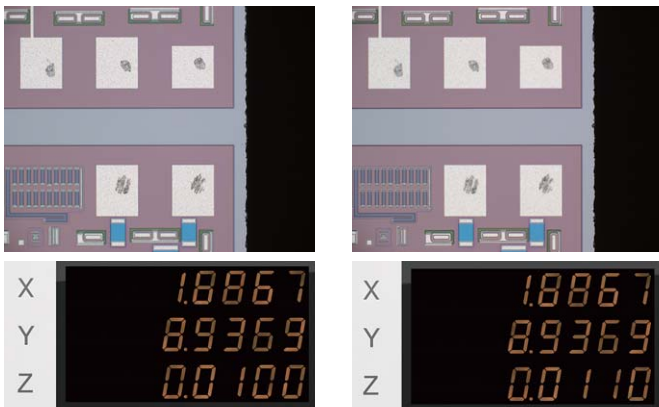

Operator subjectivity at the position at which measurements are taken can introduce differences in measurement results.

Focus Navigator

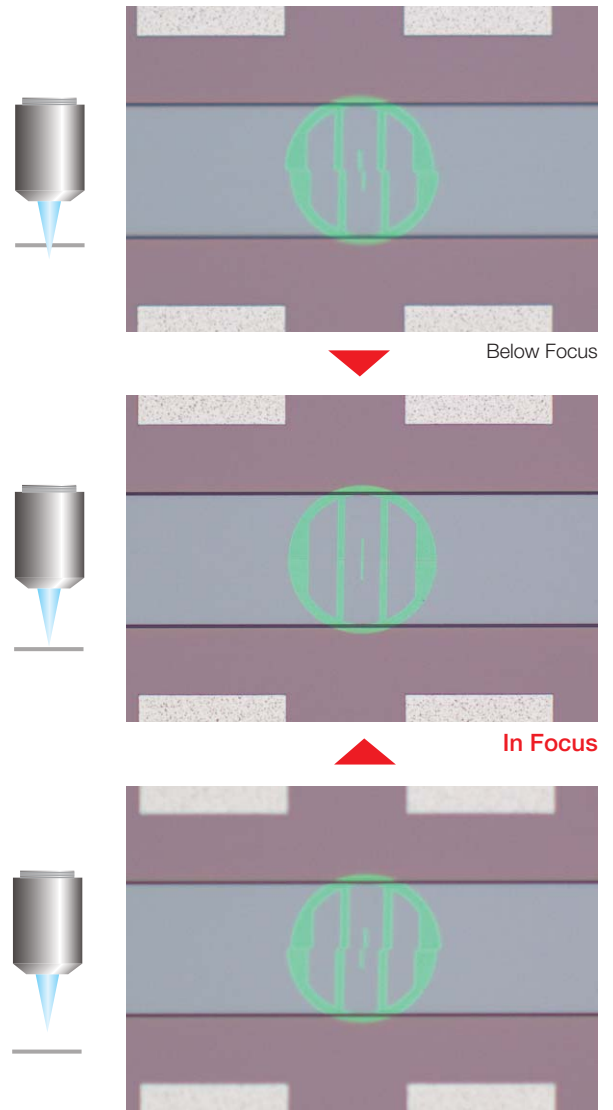

Above Focus

Autofocus Advantage for Fast and Highly Accurate Height Measurement



Common Problems

During visual measurement, the results of height measurement can vary between different operators.

Manual height measurement requires the operator to repeatedly move the stage and adjust the focus with the handle, making measurement time-consuming and inefficient.

Focusing on minute objects, such as bonding wires, is difficult.



STM7 Solutions

With use of the autofocus unit, the measured value remains highly accurate regardless of the operator.

In TRACK mode, the image is automatically and continually kept in focus, enabling efficient height measurement in minimal time. The same mode renders manual focusing unnecessary for XY measurements, resulting in even more efficient operation.

When a 100X objective is used, the laser spot diameter can be as small as 1 μm , permitting autofocus to be used locally, even on extremely minute objects.

Quick and Accurate Focusing and Measurement Free from Operator Subjectivity

Olympus has developed a dedicated autofocus unit for the STM7 series that delivers excellent reproducibility and rapid focus. As a result, highly accurate height measurements can be made within a short amount of time, irrespective of the level of operator experience.



One-shot Mode

Instantaneously takes autofocus from a roughly focused state to sharp focus located at the center of the field of view.

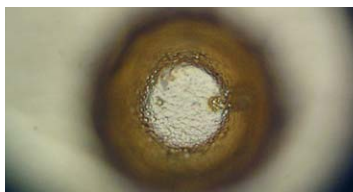

TRACK Mode

The featured TRACK Mode provides autofocus that tracks the peaks and troughs of the sample, even if the stage is moved, keeping the image continually in focus. This advancement greatly improves the efficiency of Z-axis measurements by enabling observations to be made without taking your hands off the X and Y handles.

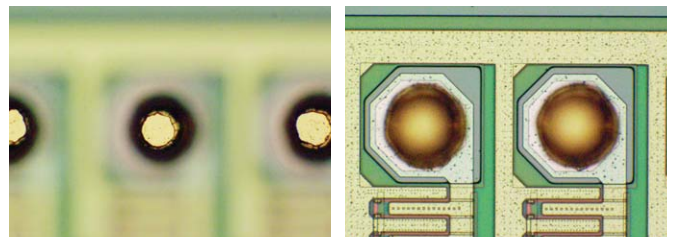

Dedicated Autofocus Unit: Outstanding Reproducibility and Focusing Speed

The STM7 dedicated autofocus unit allows highly accurate height measurements to be made with minimal time, regardless of the level of operator experience. Use of the reflective active, confocal method provides a stable focal point independent of surface roughness or a slanting sample surface, while the small laser diameter enables the use of autofocus, even on minute objects, such as bonding wires.

Measurement Support System

More Accurate, Faster, and Simpler Measurement of Objects with Complex Shapes

The ability to clearly and easily see the output display component of measuring microscopes is essential. That is why the new Olympus measuring software has been created, helping to deliver complex measurements with greater accuracy. The software also enables the use of digital cameras.

STM7-BSW Sample GUI

The screenshot displays the Olympus STM7-BSW software interface. The main window shows a live image of a circular object with a green fill and black outline. The interface includes several key components:

- Live Image Display:** The central area showing the microscope's view of the object.
- Edge Tool Bar:** A toolbar at the top of the image display for selecting and measuring edges.
- Graphic:** A panel on the right showing measured points, lines, and circles.
- Digital Indicator:** A panel on the right displaying reference and alignment coordinates (X, Y, Z).
- Measurement Items:** A panel on the right showing various measurement tools and options.
- Measurement Results:** A table at the bottom right showing the results of measurements.
- List:** A panel on the right showing the measurement procedure.
- Measurement Menu:** A menu at the bottom left for selecting measurement items.

Shows measured points, lines, circles, etc.

Shows measurement procedure

Capture Clear, Pin-Sharp Images for Highly Accurate Measurement with a Complete Lineup of Cameras

High performance model with high speed live display

DP27

Image resolution	1920 × 960 2448 × 1920
Frame rate	30 fps (1920 × 960) 15 fps (2448 × 1920)
PC interface	USB3.0



DP22

Image resolution	960 × 720 1920 × 1440
Frame rate	25 fps
PC interface	USB3.0



Introductory model with high price-performance ratio

STM7-CU

Image resolution	1024 × 768 2048 × 1536
Frame rate	11.2 fps (max.)
PC interface	USB2.0



STM7 with Measurement Support System

Place the Sample and Start to Measure – No Parallel Alignment Required

Direct Measurement

Measurements are made by receiving coordinates input via STM7.

Direct measurement Recall measurement	
	Point
	Line (angle)
	Circle
	Rectangle
	Midpoint
	Distance between point and point
	Height between point and point
	Plane
	Ellipse

Recall Measurement

Once measured and calculated, coordinates can be used again for subsequent measurements. This eliminates the need to carry out the same work twice, enabling a smoother and more efficient workflow.

Recall measurement	
	Intersection between line and line
	Center line
	Distance between point and line
	Height between point and plane
	Intersection between line and circle
	Intersection between circle and circle
	Contact point between point and circle

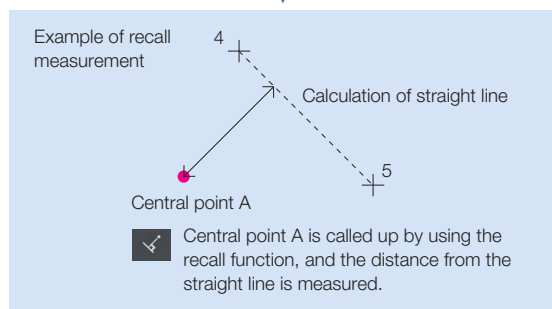
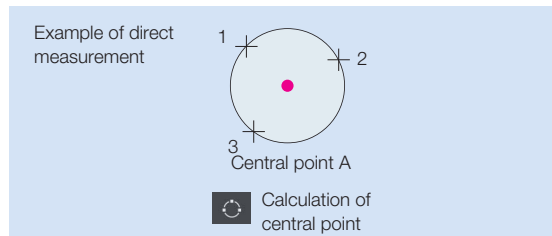

Virtual Point Measurement

Intersections, central points, lengths, and a range of other measurements can be made by drawing straight lines and circles, which can then be set to remain as reference points on acquired sample images.

Virtual point	
	Virtual point
	Move point
	Rotate point
	Point of symmetry in the X axis
	Point of symmetry in the Y axis
	Point of symmetry in the origin

Alignment Measurement

Both the origin and the X-axis are set with respect to the sample, allowing the sample to be measured even when it's not aligned with the stage.

Alignment	
	Origin
	X axis
	Move origin
	Tilt

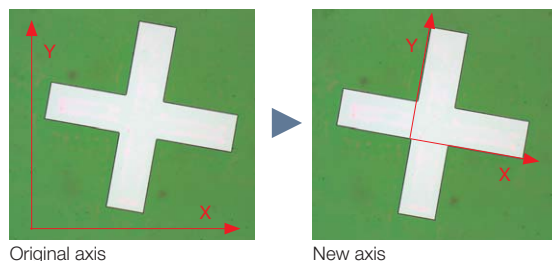

XZ Plane Measurement

Conventional measuring microscopes measure the XY plane directly from above. However in response to user demands, Olympus has incorporated an XZ plane measurement function in the STM7-BSW to enable the measurement of cross-sections as seen from the side. Now measurements that used to be difficult are much easier – such as radius measurements for vertical sections of hemispherical objects, or measurement of the depths of grooves with curved bases compared to a reference line.

XY measurement	
	Line (angle)
	Circle
	Distance between point and point
	Intersection between line and line
	Center line
	Distance between point and line
	Distance between line and circle (upper)
	Distance between line and circle (lower)

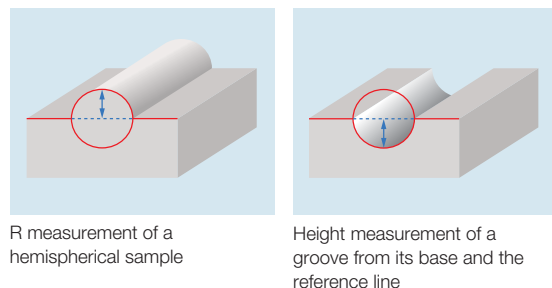

Record the Repeated Measurement Procedure

Macro Registration

Frequently used alignment and other measurement procedures can be combined and assigned to a single macro button—eliminating the need to start from scratch each time the microscope is set up.

Replay Measurement

Measurements can be easily repeated based on a recorded workflow by simply inputting the movement of the stage and the coordinates in response to a software prompt. This function can be used to repeatedly carry out the same measurement on the same sample, or different versions of the same sample. Furthermore, if a set value and tolerance are set in the recorded workflow, the software can automatically identify when a measurement has failed.

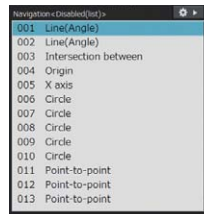

Number	Measurement	Items	Sample1	Sample2	Sample3	Stat
006	Circle	D diameter	2.0287	2.0511	2.0288	
007	Circle	D diameter	2.1352	2.0599	2.0522	
008	Circle	D diameter	2.0642	2.0457	2.0521	
009	Circle	D diameter	2.0699	1.9923	2.0680	
010	Circle	D diameter	4.0411	4.0432	4.0499	
011	Point-to-point	Distance	3.9562	3.9577	3.9419	
012	Point-to-point	Distance	6.6186	6.5118	6.5984	
013	Point-to-point	Distance	4.0149	4.0639	4.0138	

Fail/results sample

Measurement Point Navigation for Replay Measurement

This function displays the direction and distance to the next measurement point, thereby eliminating any confusion on the part of the operator. The function additionally eliminates the need to check the next measurement point on the diagram each time, speeding the operator's workflow through a series of repeated measurements.

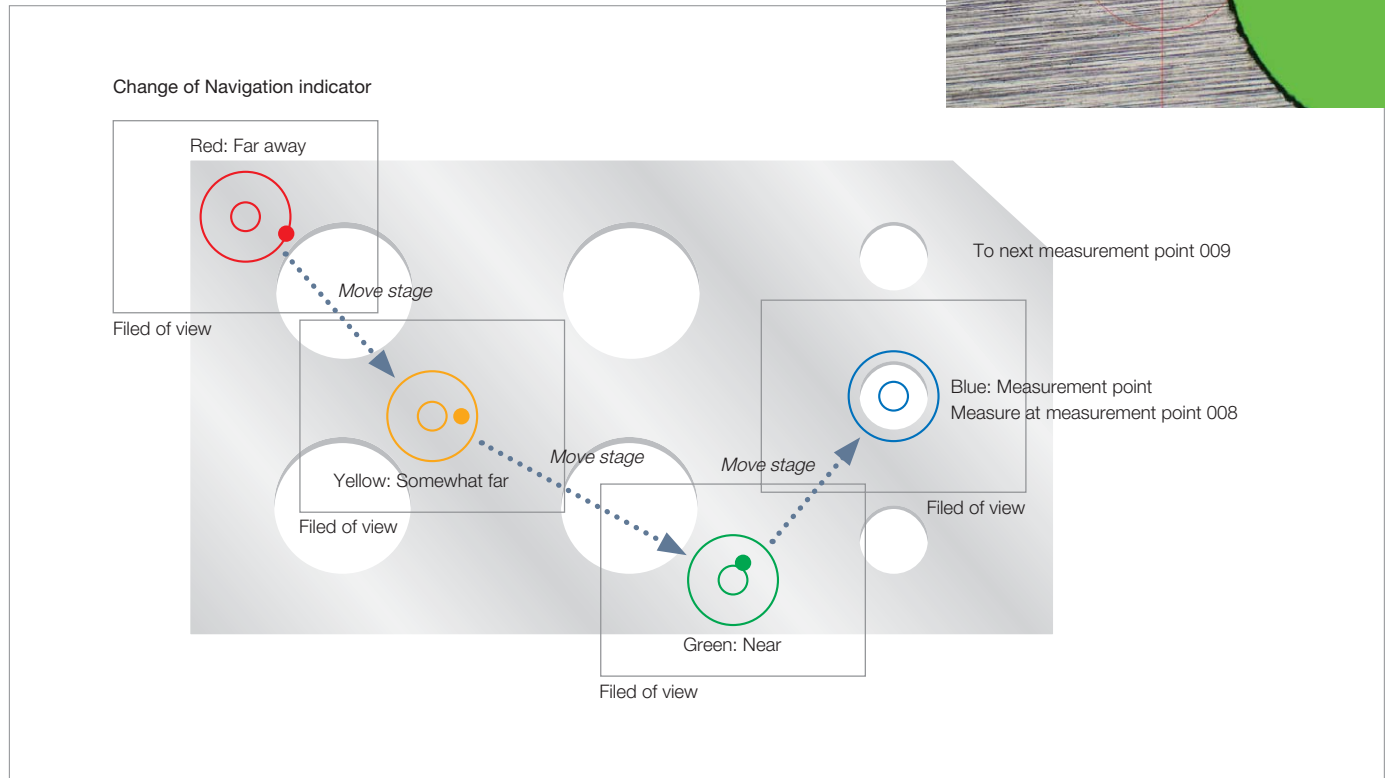
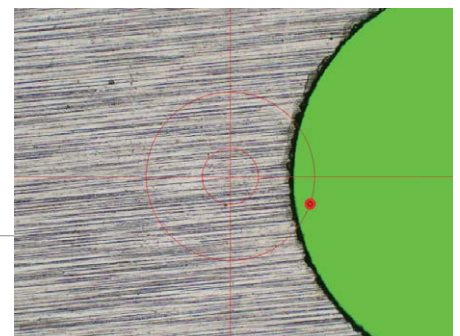
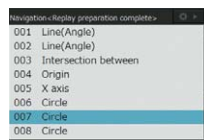

Convenient Functions Eliminate Subjectivity in Measurement

Automatic Edge Detection

This function detects the edges of the sample and automatically acquires and measures its coordinates. As a result, operators no longer need to designate the coordinates and subjectivity is minimized. Automatic Edge Detection also features a timer function that enables coordinates to be acquired in a specified time and supports the use of a foot switch that enables the operator to focus on measurement operations without taking his or her hands off the stage handles.

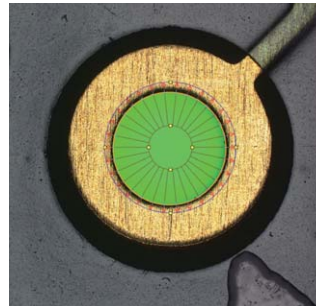

Automatic edge detection inside the circle

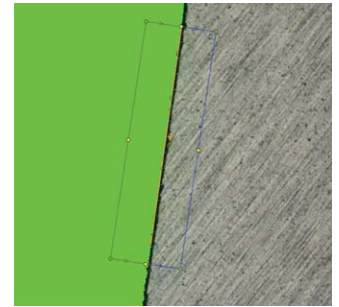

Multiple points automatic edge detection

Abnormal Point Elimination

Metal burrs and other abnormal points can be excluded automatically during edge detection. This enables a consistent calculation of measured values, irrespective of the state of the sample. Points excluded as abnormal can also be displayed on the screen in different colors.

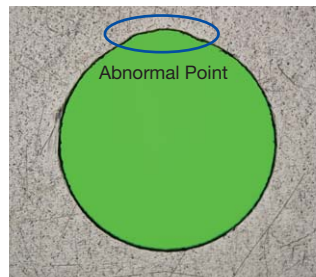

Sample with abnormal point

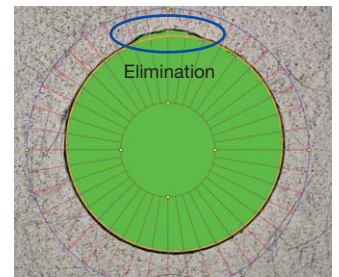

Abnormal point elimination

Illumination Control

The light intensity of the microscope can be maintained by accurate software control. Light intensity settings can also be saved when recording a workflow for replay measurement, enabling measurements to be made under the same conditions during replay measurements or automatic edge detection.

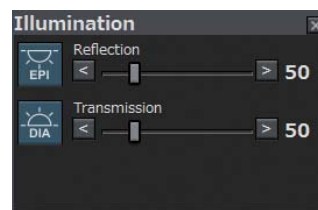

Automatic Magnification Recognition (optional, with coded revolving nosepiece configuration only)

Through use of the coded revolving nosepiece, previously set calibration values are automatically recalled when changing the objective. In this way, the user can always be confident that the proper scale is on display.

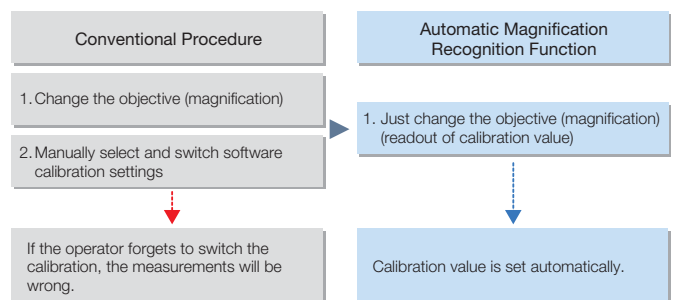

Measurement Support Software

Customizable Report Generation

One-Click Report Generation

Measurement results can be output in Excel format with a single click, eliminating mistakes made during transcription. Images can also be pasted in along with the measurement results, enabling more efficient report generation.

The screenshot shows a report window titled 'Inspection/Measuring Table'. It contains a grid of four images: a top-left image with green circles, a top-right image with a coordinate system, a bottom-left image with a green circle, and a bottom-right image with a green circle. Below the images is a large table with multiple columns and rows, containing numerical data. The table has a header row with 'Date', 'Time', 'Operator', 'Machine', 'Part No.', 'Drawing No.', 'Drawing Rev.', 'Drawing Date', 'Drawing Unit', 'Drawing Scale', 'Drawing Size', 'Drawing Color', 'Drawing Paper', 'Drawing Date', 'Drawing Unit', 'Drawing Scale', 'Drawing Size', 'Drawing Color', 'Drawing Paper'. The table contains several rows of data, including 'Date', 'Time', 'Operator', 'Machine', 'Part No.', 'Drawing No.', 'Drawing Rev.', 'Drawing Date', 'Drawing Unit', 'Drawing Scale', 'Drawing Size', 'Drawing Color', 'Drawing Paper'. The table is followed by a 'Remark' field.

Report sample

Multiple Image Alignment (MIA) optional

Tile multiple images to capture a single high-magnification, wide-area image. Because the images are tiled on the basis of coordinate data, the system is capable of producing highly reliable images.

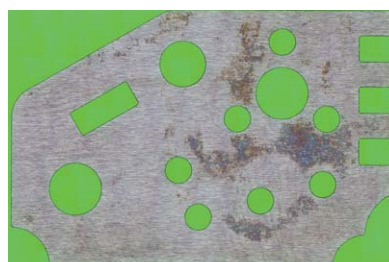
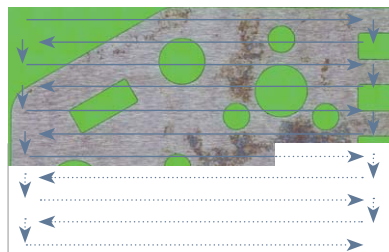

Extend Focus Image (EFI) optional

The EFI function is effective for obtaining images that are well-focused throughout on samples with an uneven, complex surface shape. Generate a single image with focal points aligned in all positions. Simply process multiple images with different focal point positions while moving the Z-axis, or use the motorized model for automated image composition.

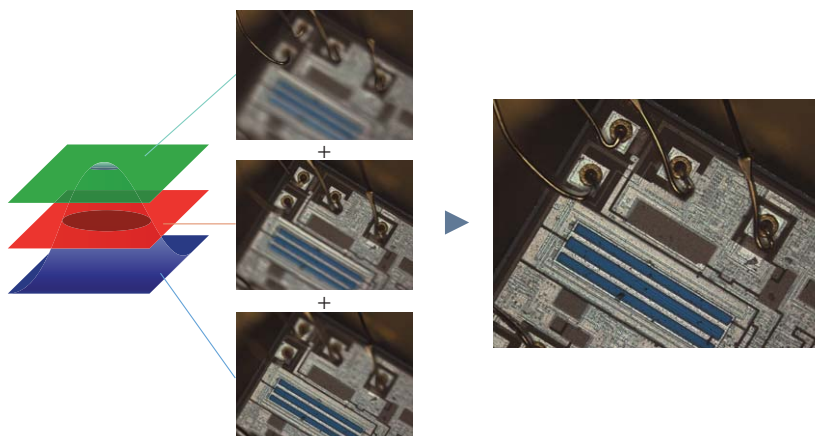

Accessories



Coded Revolving Nosepiece

Combining a coded revolving nosepiece with a digital camera lets you display the objective magnification on-screen during observation and allows you to record that magnification. This convenient feature allows information on your sample and the objective's magnification to be recorded at the same time when recording a sample.



MM6-EMO/ Erect Image Monocular Tube

Monocular tube for erect images. Can be used in combination with MM6-OCC10X (eyepiece with cross hairs).



STM7-FS/ Foot Switch

Enables hands-free transmission of data, allowing operators to complete measurement without taking hands off the X and Y handles.



SZ-LW61/ White LED Illumination Unit

This light-weight, space-saving design model provides a long operating life and low power consumption. The cost-effective LED illumination unit is also free from the flickering and brightness fluctuation.



SZX2-ILR66+SZX-RHS/ LED Ring Illuminator+Manual Control Unit

SZX-RHS manual control unit enables independent illumination of four-segments of the SZX2-ILR66 reflected LED ring illuminator, which provides clear images with high color temperature. The optimal illumination can be selected from 13 patterns.

Rotatable Stage

Enables easy parallel alignment of sample.



STM7-RS100
for STM7-CS100 100 mm x 100 mm stage



STM7-RS200
for STM7-CS200 200 mm x 200 mm stage



STM7-RS300
for STM7-CS300 300 mm x 300 mm stage

STM7-F System Diagram

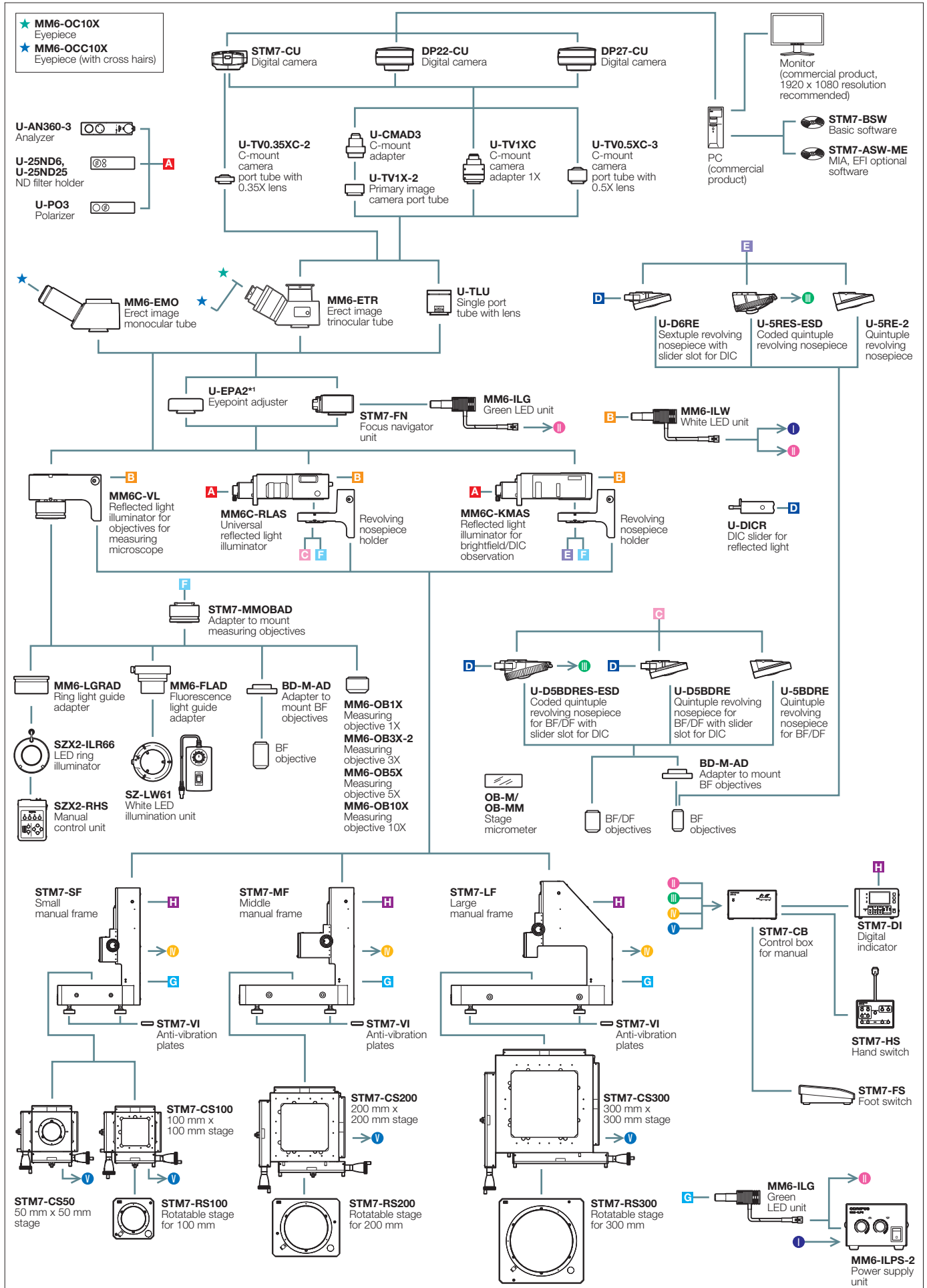

*1 STM7-LF frame combination only. Max. two mountable.

STM7-FA System Diagram

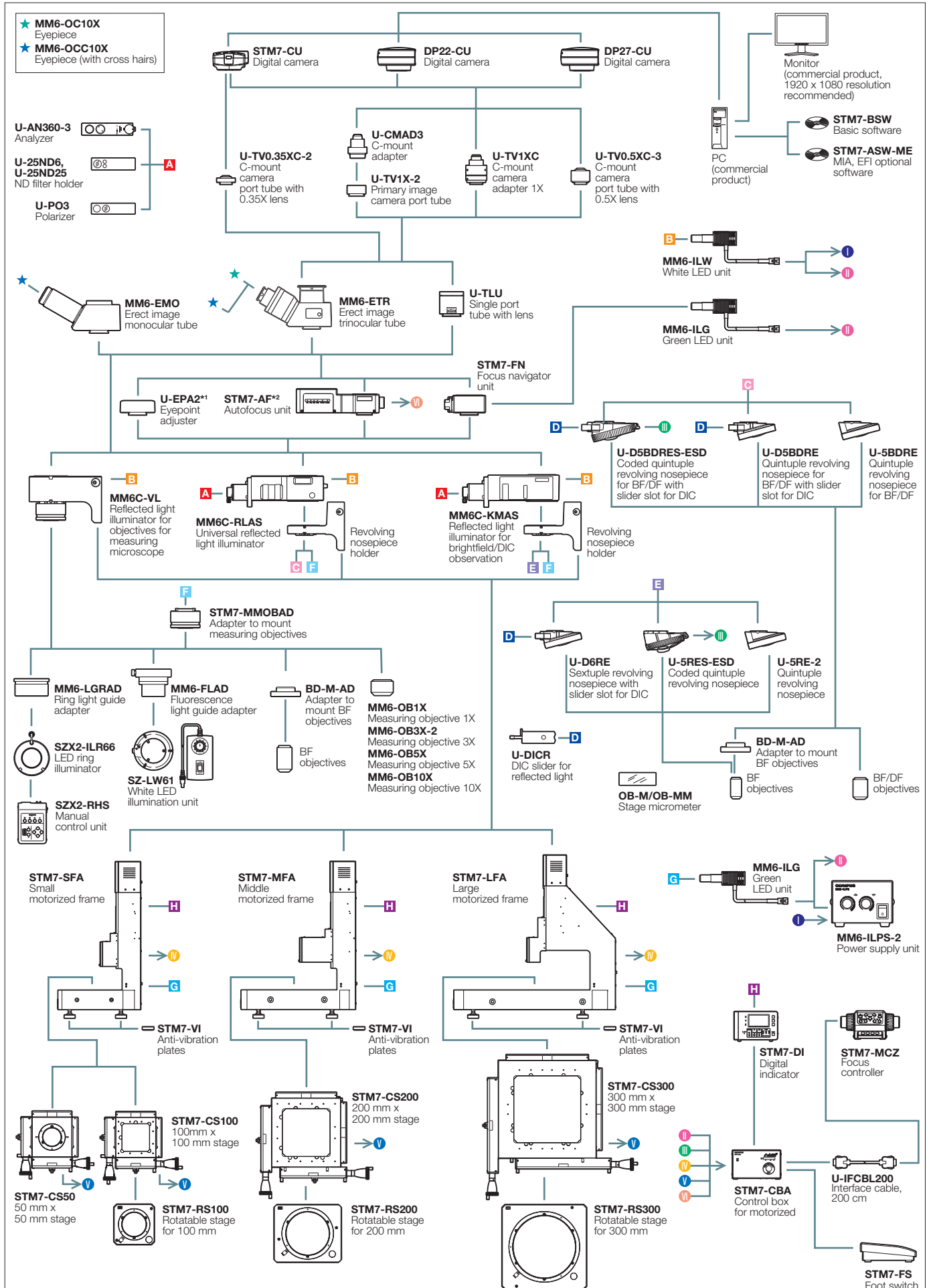

*1 STM7-LFA frame combination only. Max. two mountable. *2 STM7-AF autofocus unit is a Class 1 laser product.

Specifications

STM7 SPECIFICATIONS

		Small manual frame STM7-SF	Small motorized frame STM7-SFA	Middle manual frame STM7-MF	Middle motorized frame STM7-MFA	Large manual frame STM7-LF	Large motorized frame STM7-LFA	
Microscope body	Focus	Vertical movement range	175 mm				145 mm	
		Maximum measurable height	120 mm (with measurement objective), 175 mm (with metallurgical objective)				90 mm (with measurement objective), 145 mm*1 (with metallurgical objective)	
		Z-axis measurement resolution	0.1 μm					
	Z-axis drive method	Manual coaxial fine/coarse focusing knobs	Motorized •FOCUS button: Coarse movement speed 8 mm/s (max.) •Fine/coarse focusing knob: Fine focusing speed can be selected from 4 values (800 μm, 400 μm, 100 μm, 50 μm)	Manual coaxial fine/coarse focusing knobs	Motorized •FOCUS button: Coarse movement speed 8 mm/s (max.) •Fine/coarse focusing knob: Fine focusing speed can be selected from 4 values (800 μm, 400 μm, 100 μm, 50 μm)	Manual coaxial fine/coarse focusing knobs	Motorized •FOCUS button: Coarse movement speed 8 mm/s (max.) •Fine/coarse focusing knob: Fine focusing speed can be selected from 4 values (800 μm, 400 μm, 100 μm, 50 μm)	
illumination	LED illumination	White: for reflected light illumination, green: for transmitted light illumination						
Observation tube		Erect image monocular tube, erect image trinocular tube (100:0/0:100)						
Objective	For measuring microscope	MM6-OB series						
	For metallurgical microscope	MPLFLN series, LMPLFLN series, MPLFLN-BD series, LMPLFLN-BD series						
Eyepiece		MM6-OCC10X (with cross hairs, FN 22), MM6-OC10X (FN 22)						
Stage	Measuring range	STM7-CS50: X-axis 50 mm, Y-axis 50 mm STM7-CS100: X-axis 100 mm, Y-axis 100 mm		STM7-CS200: X-axis 200 mm, Y-axis 200 mm		STM7-CS300: X-axis 300 mm, Y-axis 300 mm		
	Measurement accuracy (L: measuring length)	STM7-CS50: (3+L/50) μm STM7-CS100: (3+2L/100) μm		(3+4L/200) μm		(3+6L/300) μm		
	Accuracy assurance weight	STM7-CS50: 5 kg STM7-CS100: 6 kg		10 kg		15 kg		
Counter display	Number of axes	Three						
	Unit	mm/μm/inch/mil						
	Minimum resolution	0.1 μm						
Dimensions (W x D x H) (mm)		466 x 583 x 651	466 x 583 x 811	606 x 762 x 651	606 x 762 x 811	804 x 1024 x 686	804 x 1024 x 844	
Weight		84 kg (Approx.)	92 kg (Approx.)	152 kg (Approx.)	159 kg (Approx.)	277 kg (Approx.)	284 kg (Approx.)	
Power consumption		100-120/220-240V ~ 50/60Hz 0.3A/0.2A	100-120/220-240V ~ 50/60Hz 0.6A/0.35A	100-120/220-240V ~ 50/60Hz 0.3A/0.2A	100-120/220-240V ~ 50/60Hz 0.6A/0.35A	100-120/220-240V ~ 50/60Hz 0.3A/0.2A	100-120/220-240V ~ 50/60Hz 0.6A/0.35A	

*1 When using the large frame STM7-LF/STM7-LFA, a specimen whose height is 100 mm or less can be placed at the position backward from the light axis by 180 mm or more.

OBJECTIVES WORKING DISTANCE

Objective	Magnifications		1X	3X	5X	10X	20X	50X	100X
Measuring objectives	MM6-OB series		59.6	76.8	65.4	50.5	—	—	—
	MPLFLN series	Brightfield	—	—	20.0	11.0	3.1	1.0	1.0
Metallurgical objectives	LMPLFLN series		—	—	22.5	21.0	12.0	10.6	3.4
	MPLFLN-BD series		—	—	12.0	6.5	3.0	1.0	1.0
	LMPLFLN-BD series		Brightfield/darkfield, long working distance	—	—	15.0	10.0	12.0	10.6

STM7-BSW SYSTEM REQUIREMENTS

Item	System Configurations
CPU	Intel Core i3 Processors 3 GHz or more
Memory	4 GB or more
HD available space	100 GB or more hard disk space for installation SSD hard disk is recommended for high speed image acquisition
Graphic card	Graphic card available for resolution 1980x1080 and 32bit color
Drive	DVD Drive
PC input device	2-button mouse (3-button mouse with a wheel is recommended.) Keyboard
Operating system	Microsoft Windows 10 Pro (32bit / 64bit) Microsoft .NET Framework 3.5
Web browser	Internet Explorer 8.0

• Microsoft Office 2010/2013/2016 are also supported.

Dimensions

STM7-SF

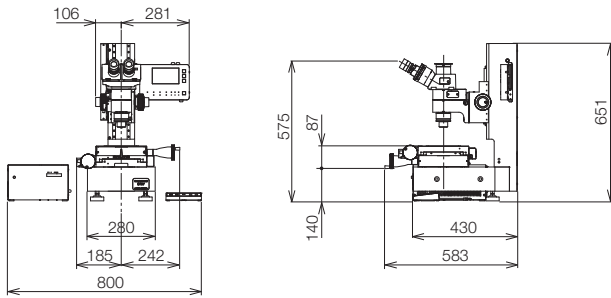

Unit: mm

STM7-SFA

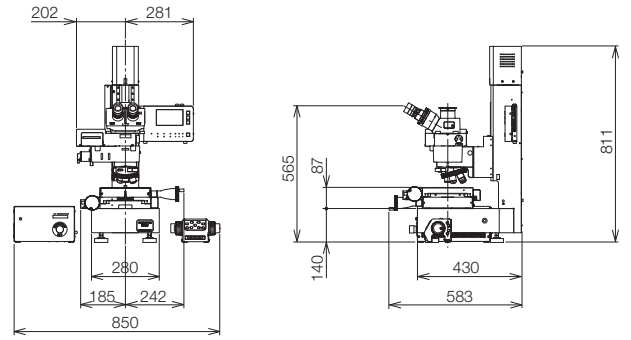

Unit: mm

STM7-MF

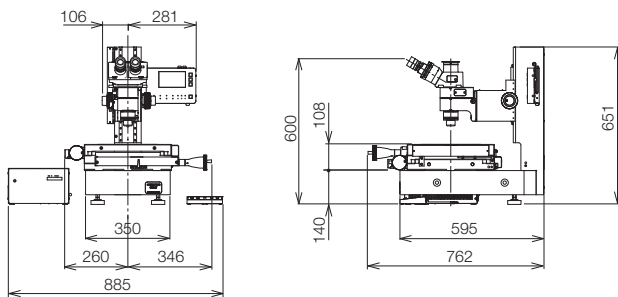

Unit: mm

STM7-MFA

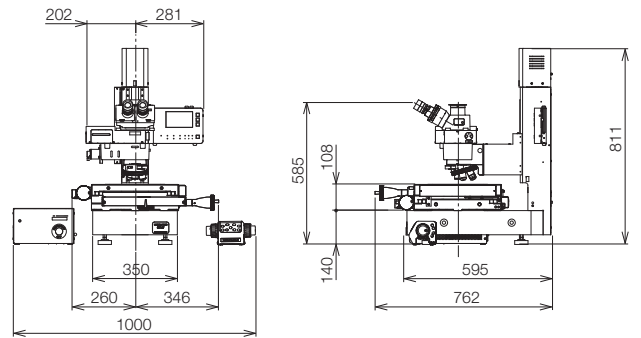

Unit: mm

STM7-LF

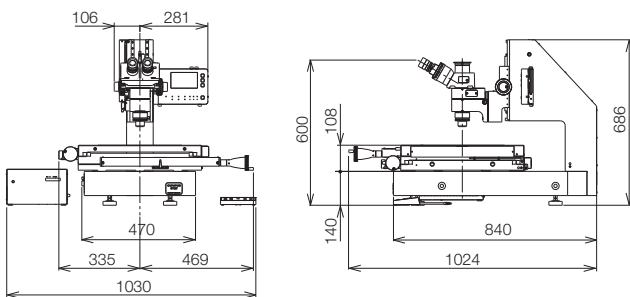

Unit: mm

STM7-LFA

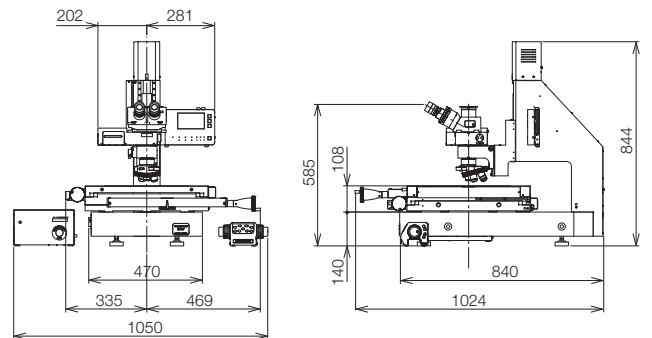

Unit: mm

www.olympus-ims.com

OLYMPUS[®]

For enquiries - contact

www.olympus-ims.com/contact-us

OLYMPUS CORPORATION

Shinjuku Monolith, 2-3-1, Nishi-Shinjuku, Shinjuku-ku, Tokyo 163-0914, Japan

OLYMPUS SCIENTIFIC SOLUTIONS AMERICAS CORP.

48 Woerd Avenue, Waltham, MA 02453, U.S.A.

OLYMPUS (CHINA) CO., LTD.

10F, K. Wah Centre, 1010 Huai Hai Road (M), Xuhui District, Shanghai, 200031 P.R.C.

OLYMPUS MEDICAL SYSTEMS INDIA PRIVATE LIMITED.

102-B, First Floor, Time Tower, M.G. Road, Gurgaon 122001, Haryana, INDIA

OLYMPUS KOREA CO., LTD.

8F Olympus Tower, 446 Bongeunsa-ro, Gangnam-gu, Seoul, 135-509 Korea

OLYMPUS AUSTRALIA PTY. LTD.

3 Acacia Place, Notting Hill VIC 3168, Australia

OLYMPUS SINGAPORE PTE LTD.

491B River Valley Road, #12-01/04 Valley Point Office Tower, Singapore 248373

• **OLYMPUS CORPORATION is ISO14001 certified.**

• **OLYMPUS CORPORATION is ISO9001 certified.**

- This product is designed for use in industrial environments for the EMC performance. Using it in a residential environment may affect other equipment in the environment.
 - All company and product names are registered trademarks and/or trademarks of their respective owners.
 - Images on the PC monitors are simulated.
 - Specifications and appearances are subject to change without any notice or obligation on the part of the manufacturer.
 - Illumination devices for microscope have suggested lifetimes. Periodic inspections are required.
- Please visit our web site for details.