

From Eye to Insight



LEICA DM2700 M

The reliable and convenient upright materials microscope with bright universal LED illumination.





Simple and Reliable: The Leica DM2700 M

See materials in the best light

Examine materials in the best light. The universal white light (4500 K) LED illumination in combination with renowned high quality Leica optics provide the ideal inspection tool for all of your quality assessments. The Leica DM2700 M demonstrates how simple and reliable microscopy can be, while at the same time, helps to improve your workflow so you can concentrate on the task at hand.

- › Brilliance
- › Reliability
- › Flexibility
- › Easy Documentation

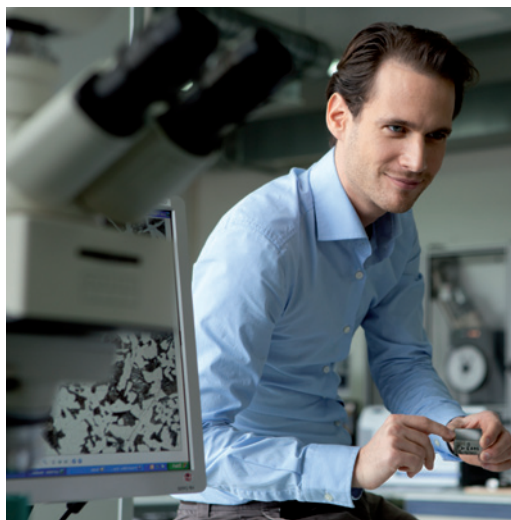
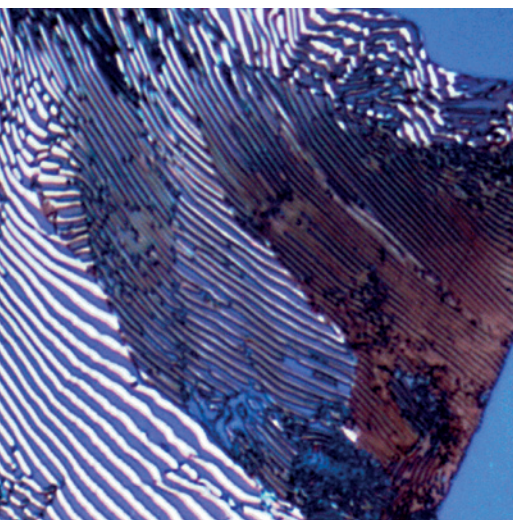

LED Illumination, Daylight at a Touch

The universal microscope illumination for a wide range of industrial applications

A powerful light source for Brightfield, Darkfield, Differential Contrast, and Polarized Light applications:

- › white light, constant color temperature
- › true color imaging
- › entirely adjustment-free
- › and lasts 20 years

Enter the future of microscopy.

LED ILLUMINATION – “CONSTANT” LIGHT

Ultra bright, high-power LED illumination

- › Constant color temperature of 4500 K
- › True to life color imaging at all intensity levels
- › Long life time (35k h) at 8 h/day = 20 years
- › Adjustment-free
- › No down time (bulb exchange)
- › For BF, DF, DIC, POL and Oblique Illumination
- › No heat production
- › Intensity perception higher than 100 W halogen bulb



Images on the right: Universal LED illumination.

Image Brilliance You Can Count On

Top of the line optics

A microscope is as good as its optics. This statement is still true for in today's digital world. The brand Leica Microsystems has always represented the highest standards in optical performance. Leica objectives are innovative, cost-effective, and always provide high-contrast, pin sharp images as seen through the eyepieces and captured with digital cameras. They combine brilliance and sharp contrast with high resolution and optimized image fields. Whatever your work demands Leica Microsystems offers an affordable solution.

BRILLIANCE – YOU CAN'T AFFORD LOW QUALITY

N Plan achromatic objective series

- › Magnifications: 5x, 10x, 20x, 50x, 100x
- › FOV Ø: 22 mm
- › Flattened image field
- › Large working distances

4 objective series to choose from

- › H Plan EPI
- › N Plan EPI plus LWD
- › PL FLUOTAR plus LWD
- › PLAN APO incl. 0.7x Macro



Image on the right: N PLAN EPI series of objectives (plan achromat)

Reliability You Can Count On

We don't make a science out of microscope operation

Uncomplicated AND easy to understand functionality is built into the design of the Leica DM2700 M. Concentrate on your work, not on microscope adjustments.

BENEFITS

The combination of Leica's color coded objectives and the aperture diaphragm results in the Color Coded Diaphragm Assistant (CCDA). With it, the basic setting of resolution, contrast, and depth of field is simple and straightforward. The built-in focus stop, the height adjustable focus knobs, as well as the

three-gear focus mechanism for coarse, fine, and ultra-fine focusing make the Leica DM2700 M convenient and reliable for daily use. It can dramatically speed up your work processes while minimizing operating errors. Using a manual microscope has never been easier. Accept no compromises when it comes to

operation, performance, and features. The Leica DM2700 M is sturdy, durable, and ergonomically designed for ease of use and user comfort.

RELIABILITY AND CONVENIENCE

The Color Coded Diaphragm Assistant (CCDA)

- › Reliable results
- › Easy, intuitive operation
- › Minimal orientation time
- › Avoids operating errors

Built-in focus stop

- › Protects and objectives

Built-in oblique contrast

- › Quick view of topographic features
- › Simple one-finger operation
- › Great help when DIC is not available

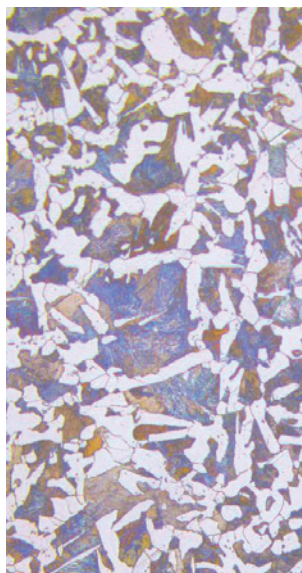

Ferrit C60, etched, under eutectoid, ferrite-perlite grain structure. LED brightfield, 500x

Flexibility Means Saving Money

Versatility for all samples

The Leica DM2700 M is a flexible upright microscope system for Brightfield (BF), Darkfield (DF), Differential Interference Contrast (DIC), Qualitative Polarization (POL), and Fluorescence (FLUO) applications. In addition to all incident light applications, the Leica DM2700 M can also be equipped with transmitted light.

OBJECTIVE TURRETS

There are three objective turrets to choose from: The BF/DF M32 nosepiece holds up to five objectives, while the (BF/FLUO) can accommodate six or seven objectives.

FLEXIBLE IN EVERY APPLICATION

Specimens with a size of up to 100 × 100 mm – such as foils, wafers or PCBs – and a thickness of up to 80 mm, such as machined components, can be examined using the comprehensive stage program.

KEEP TRACK OF YOUR SAMPLES

The Macro objective enables you to see almost 40 mm of the sample at a glance. The ideal addition for fast orientation and overview documentation.

FLEXIBILITY IS THE KEY FOR ALL SAMPLES

Flexibility in the stand

- › Incident light axis with high quality DF
- › Built-in Oblique Illumination
- › 3 objective turrets
- › 0.7x Macro Objective, see almost 40 mm of your sample at a glance
- › Optional transmitted light
- › Flexibility for all
- › up to 100 × 100 mm
- › height up to 80 mm
- › All microscopic contrast methods available



Documentation Simplified

Documenting, saving, and retrieving images

Leica digital cameras, optimized for reflected light applications, in combination with Leica Application Suite (LAS) image acquisition and archiving software, ensure convenient and efficient documentation of your results.

QUICK AND PRECISE ANALYSIS OF MATERIALS DATA

Leica Steel Expert, Phase & Grain Expert, and Cleanliness Expert are dedicated software packages that provide high-quality solutions, particularly in environments that require high sample throughput and automated operation. With a modular structure, the functionality ranges from simple, interactive to automated photogrammetry; for example, characterizing metal surfaces or particle analysis.

EASY DOCUMENTATION WITH LEICA CAMERAS AND SOFTWARE

Digital cameras, HD-imaging

- › Fast live image preview
- › Image resolution from 1.3 to 8 megapixels
- › Exposure time of 100 μ sec to 30 seconds
- › Color depth of up to 16 bits per color channel

Image archiving/image analysis, Leica Application Suite

- › From simple image archiving to fully automated expert
- › The routine tool for materials analysis (Leica Grain & Phase Expert)
- › The tool for quality steel (Leica Steel Expert)
- › The dedicated tool for cleanliness analysis (Leica Cleanliness Expert)

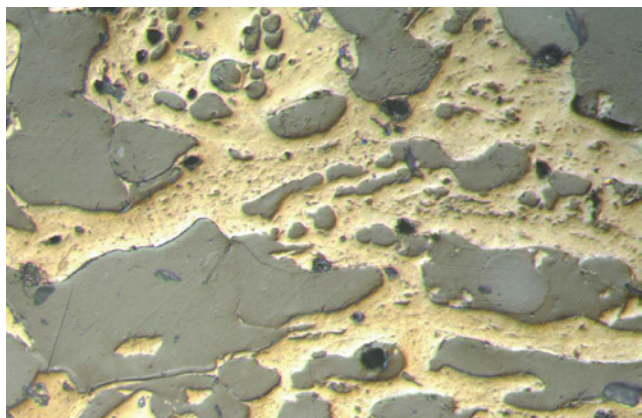
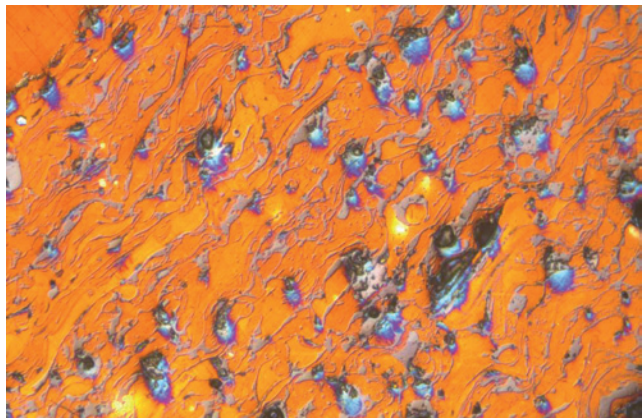

Upper image: Coated and annealed brass sample in LED brightfield-oblique contrast, 500x.
Lower image: Plastic composite material in LED brightfield-oblique contrast, 200x.
3D-like image due to oblique illumination.



Dimensions

Leica DM2700 M

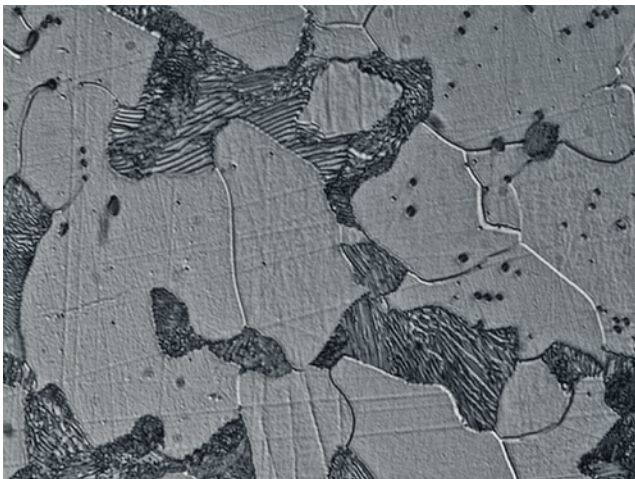
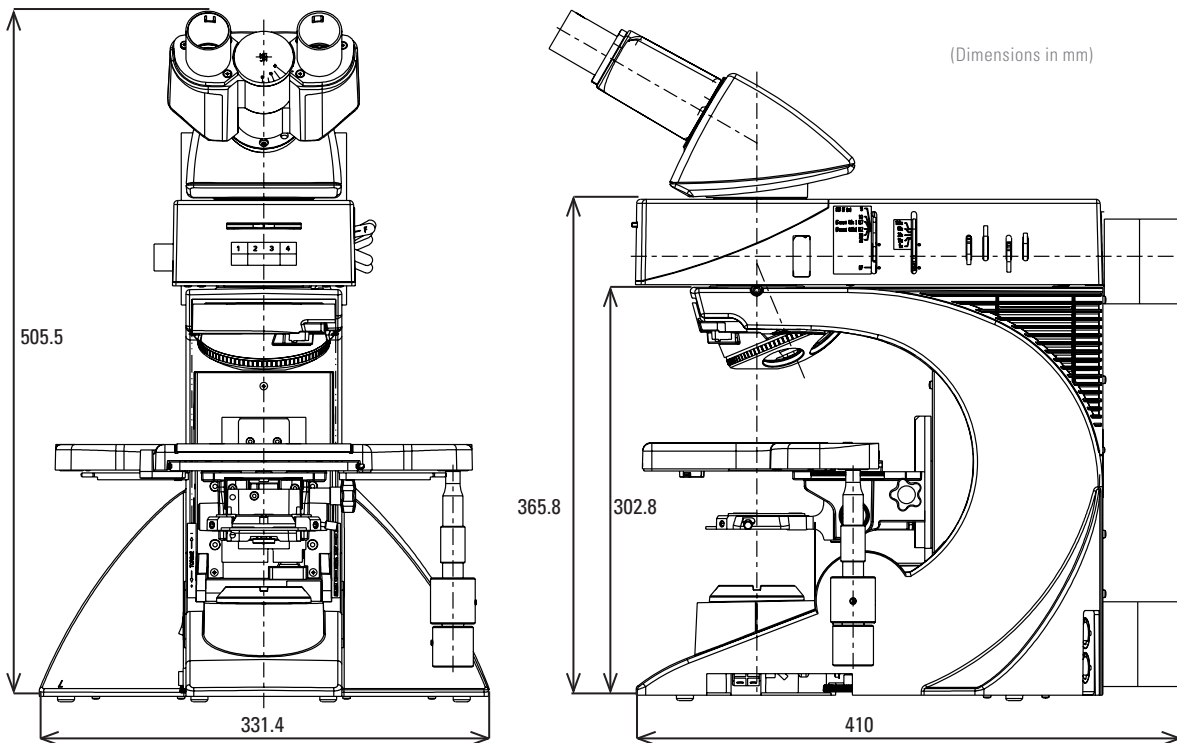

Undereutectoid, ferrit-perlite grain structure LED brightfield-oblique contrast, N Plan 100x

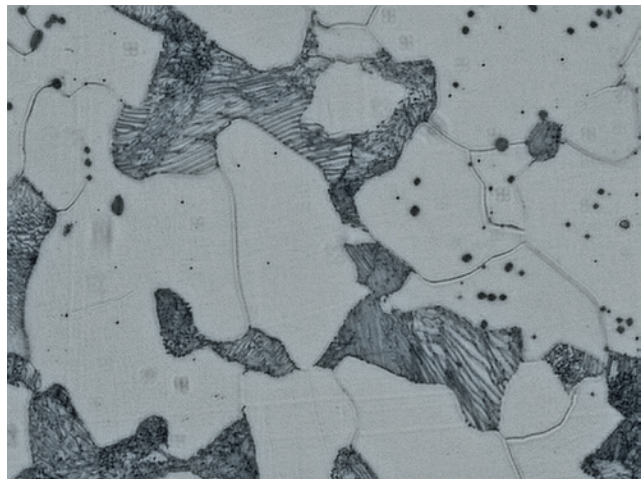

Undereutectoid, ferrit-perlite grain structure LED brightfield contrast, N Plan 100x

Specifications

Leica DM2700 M

Stand	Sturdy metal stand
Focusing	2-gear focusing (coarse/fine with 1 µm micrometer scale with top focus stop) or 3-gear focusing (coarse/medium/ fine with 1 and 4 µm micrometer scales with top focus stop) Torque coarse focus, adjustable stage height stop
Stage stroke	25 mm
Incident light	Robust incident light axis with 4-position reflector turret for BF/DF/POL/DIC and FLUO <ul style="list-style-type: none"> › with oblique illumination › with Color-coded Diaphragm Assistant (CDA) › with centreable Aperture iris diaphragm › with IL-Filter magazine for 2 filters – Ø 32 mm <p>The following light sources can be adapted to all incident light axes:</p> <ul style="list-style-type: none"> › LED-Lamphousing with internal microscope control of the light intensity for IL and TL (standard) › Mirrorhousing 106, for simultaneous adaptation of two light sources › Fluo-illumination SFL 100, 4000 and 7000 › EL 6000, Hg 50, Hg 100, Xe 75 › 12 V 100 W Halogen (Lamp housing series 106 or 107/2) with separate transformer 11xxxxxx
Objective turret/	5x BF/DF M32, 6x BF M25 and 7x BF M25 objective turret
Objectives	<ul style="list-style-type: none"> › HI PLAN EPI Objectives 5x, 10x, 20x › N PLAN EPI Objectives 2.5x–100x › PLAN FLUOTAR Objectives 1.25x–100x › PLAN APO Objectives 0,7x Macro 50x, 100x, 150x
Accessories	Optional magnification changer (1x, 1.5x, 2x). Fixed ergonomic stage (76 × 50 mm), left and right-hand operation or rotating stage (76 × 50 mm) with wear-resistant ceramic surface belong to the standard product line for industrial tasks with stage brackets and condenser holder. Optional measuring stage s for x,y and z measurements.
Transmitted light	LED-Lamphousing with internal light intensity control. Built-in filter magazine with 3-position, for filters Ø 32 mm. Wide range of condensers for TL applications.
Power supply	Stabilized universal power supply unit, 90–230 V

The statement by Ernst Leitz in 1907, “With the User, For the User,” describes the fruitful collaboration with end users and driving force of innovation at Leica Microsystems. We have developed five brand values to live up to this tradition: Pioneering, High-end Quality, Team Spirit, Dedication to Science, and Continuous Improvement. For us, living up to these values means: **Living up to Life.**

Leica Microsystems operates globally in three divisions, where we rank with the market leaders.

LIFE SCIENCE DIVISION

The Leica Microsystems Life Science Division supports the imaging needs of the scientific community with advanced innovation and technical expertise for the visualization, measurement, and analysis of microstructures. Our strong focus on understanding scientific applications puts Leica Microsystems’ customers at the leading edge of science.

INDUSTRY DIVISION

The Leica Microsystems Industry Division’s focus is to support customers’ pursuit of the highest quality end result. Leica Microsystems provide the best and most innovative imaging systems to see, measure, and analyze the microstructures in routine and research industrial applications, materials science, quality control, forensic science investigation, and educational applications.

MEDICAL DIVISION

The Leica Microsystems Medical Division’s focus is to partner with and support surgeons and their care of patients with the highest-quality, most innovative surgical microscope technology today and into the future.

Leica Microsystems – an international company with a strong network of worldwide customer services:

Active worldwide		Tel.	Fax
Australia · North Ryde	+61	2 8870 3500	2 9878 1055
Austria · Vienna	+43	1 486 80 50 0	1 486 80 50 30
Belgium · Diegem	+32	2 790 98 50	2 790 98 68
Canada · Concord/Ontario	+1	800 248 0123	847 405 0164
Denmark · Ballerup	+45	4454 0101	4454 0111
France · Nanterre Cedex	+33	811 000 664	1 56 05 23 23
Germany · Wetzlar	+49	64 41 29 40 00	64 41 29 41 55
Italy · Milan	+39	02 574 861	02 574 03392
Japan · Tokyo	+81	3 5421 2800	3 5421 2896
Korea · Seoul	+82	2 514 65 43	2 514 65 48
Netherlands · Rijswijk	+31	70 4132 100	70 4132 109
People’s Rep. of China · Hong Kong	+852	2564 6699	2564 4163
· Shanghai	+86	21 6387 6606	21 6387 6698
Portugal · Lisbon	+351	21 388 9112	21 385 4668
Singapore	+65	6779 7823	6773 0628
Spain · Barcelona	+34	93 494 95 30	93 494 95 32
Sweden · Kista	+46	8 625 45 45	8 625 45 10
Switzerland · Heerbrugg	+41	71 726 34 34	71 726 34 44
United Kingdom · Milton Keynes	+44	800 298 2344	1908 246312
USA · Buffalo Grove/Illinois	+1	800 248 0123	847 405 0164