

TrueView II

A Further Step in Arthroscopy

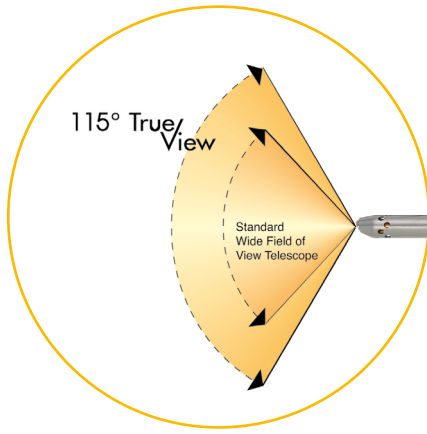



Olympus TrueView II telescopes are based on a completely new and revolutionary lens system. The unique wide field of view allows a tremendous image size with low distortion. The 115° field of view supports easy navigation in the joint with less rotation of the telescope. Beyond that a quick-lock mechanism for tight and secure camera connection is used. The overall quality of Olympus telescopes is reflected by a special warranty on autoclavability. It is the combination of outstanding optical performance and durable mechanical design that makes Olympus telescopes something special.



VISERA

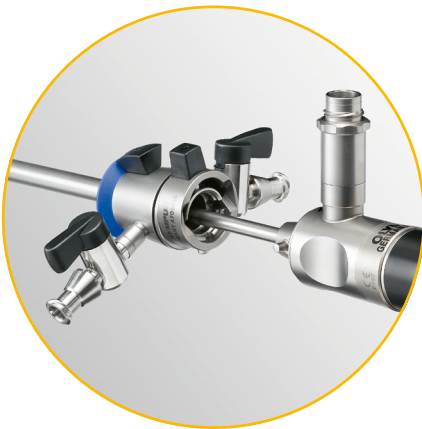

Arthroscopy continuously demands innovative developments. It has, therefore, always been a challenge for Olympus to present not only new but also unique products. Based on our intensive cooperation with leading surgeons arthroscopes with outstanding features and benefits were designed.

Quick-lock:

- Allows to put on and take off arthroscopes with just one touch. Plus, it has minimal projection, making it easier to handle and obtain perfect viewing position.
- Automatic click connector
- High-flow trocar design

Arthroscopy



4 mm Arthroscopes

TrueView II

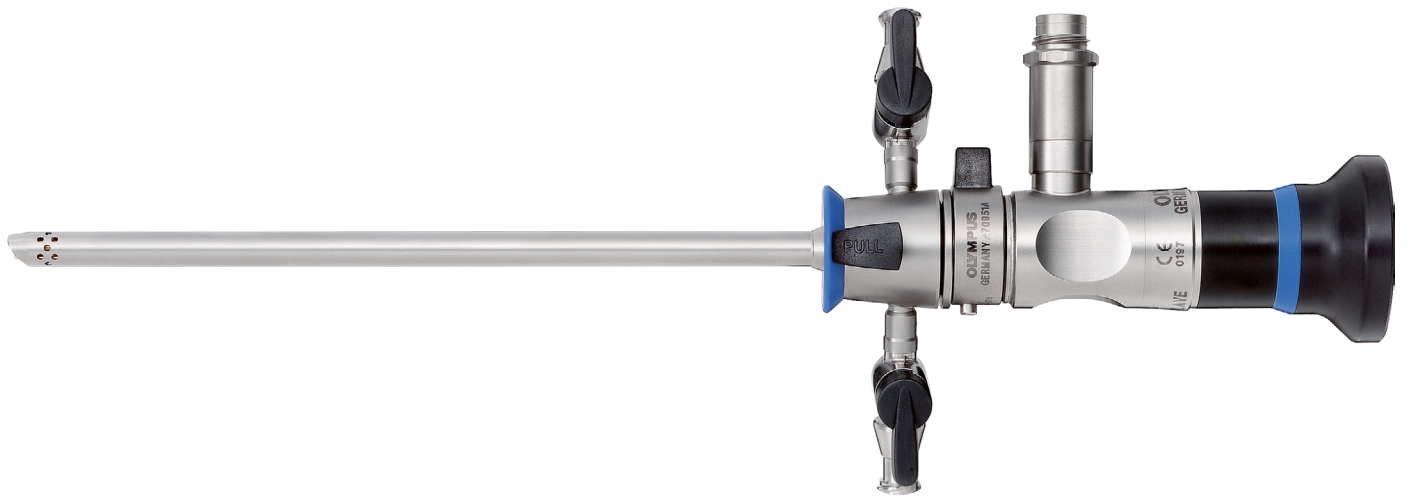

- 115° wide angle field of view
- Nearly distortion-free image
- Automatic click-connector
- High-flow trocar design



4 mm TrueView II Telescopes

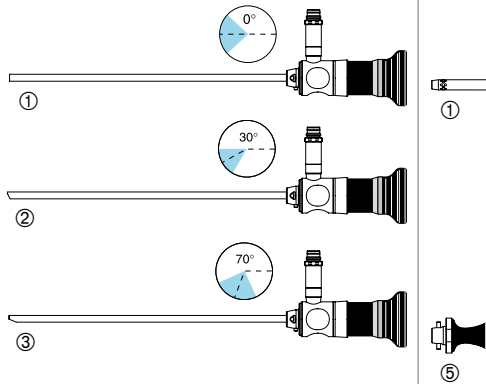

- ① **A70940A** Telescope, autoclavable, 0° direction of view, 115° field of view, 160 mm working length

- ② **A70941A** Telescope, autoclavable, 30° direction of view, 115° field of view, 160 mm working length

- ③ **A70942A** Telescope, autoclavable, 70° direction of view, 115° field of view, 160 mm working length

Accessories and Spare Parts for Telescopes

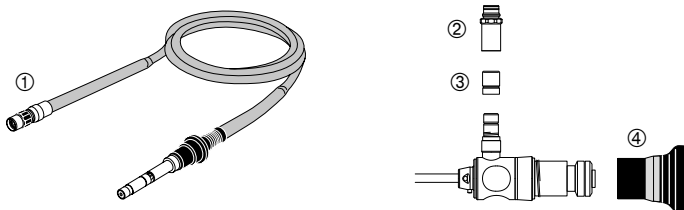

- ① **WA03300A** Light-guide cable, 2.8 mm, 3 m, CF type

- ② **A0460** Light-guide adapter, for OES 4000 light-guide cables

- ③ **00332** Light-guide adapter, for Wolf light-guide cables

- ④ **A5333** Eyepiece cup, for telescopes

4 mm Trocars and Accessories

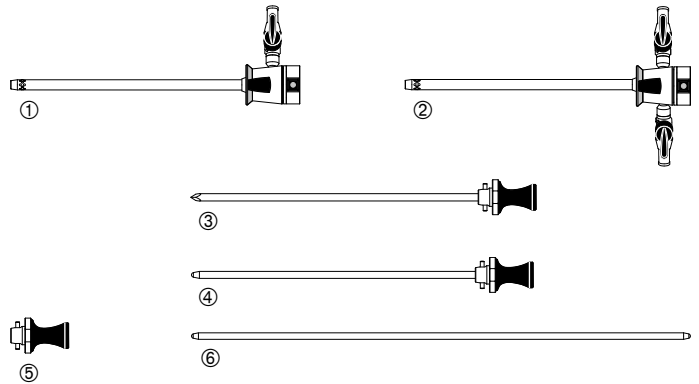

- ① **A70950A** Trocar tube, 1 stopcock, rotatable, high-flow

- WA70952A** Trocar tube, 1 stopcock, rotatable, standard flow

- ② **A70951A** Trocar tube, 2 stopcocks, rotatable, high-flow

- WA70951B** Trocar tube, 2 stopcocks, rotatable, high-flow, without holes

- WA70953A** Trocar tube, 2 stopcocks, rotatable, standard flow

- ③ **A70954A** Trocar spike, triangular

- ④ **A70955A** Trocar spike, blunt

- ⑤ **A70959A** Cover, for trocars, for lavage

- ⑥ **A70958A** Guiding rod, 4 mm

- A00507A** Sealing, set (not shown), for A70950A/-951A, WA70951B/-52A/53A

Insert Tray for Arthroscopy

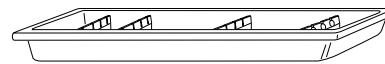

- A05951A** Insert tray, for TrueView II

☑ For plastic instrument trays, see page 651.

Accessories

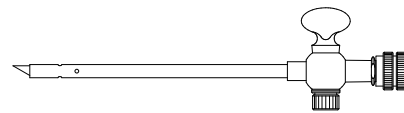

- A7535** Cannula, 3.2 mm, for drainage

2.7 mm Arthroscopes

TrueView II

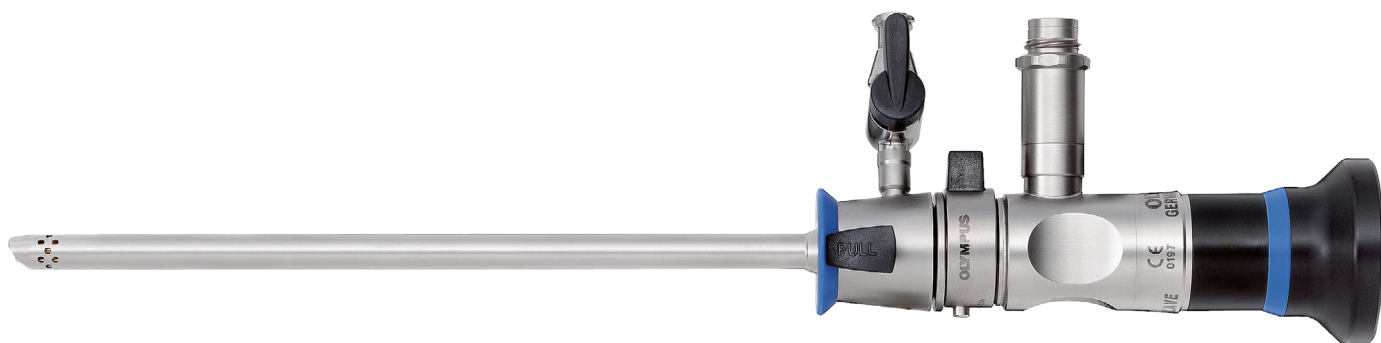

- Image size same as with 4 mm telescopes
- Standard and high-flow trocars
- Two working lengths for 30° system
- Long lasting design



2.7 mm TrueView II Telescopes

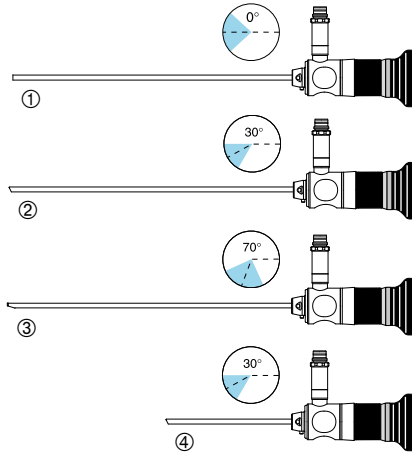

- ① **A70960A** Telescope, autoclavable, 0° direction of view, wide angle field of view, 160 mm working length
- ② **A70961A** Telescope, autoclavable, 30° direction of view, wide angle field of view, 160 mm working length
- ③ **A70962A** Telescope, autoclavable, 70° direction of view, wide angle field of view, 160 mm working length
- ④ **A70963A** Telescope, autoclavable, 30° direction of view, wide angle field of view, 70 mm working length

Accessories and Spare Parts

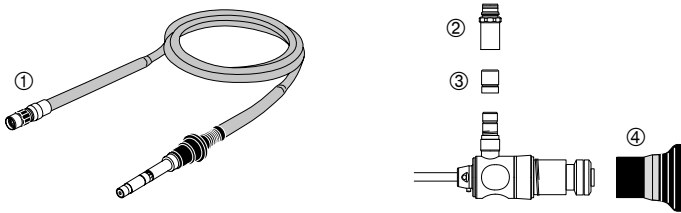

- ① **WA03300A** Light-guide cable, 2.8 mm, 3 m, CF type
- ② **A0460** Light-guide adapter, for OES 4000 light-guide cables
- ③ **00332** Light-guide adapter, for Wolf light-guide cables
- ④ **A5333** Eyepiece cup, for telescopes

2.7 mm Trocars and Accessories

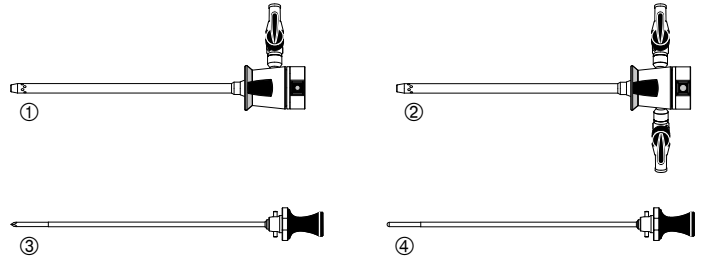

- ① **A70970A** Trocar tube, rotatable, 1 stopcock, for 160 mm telescopes, high-flow
- WA70990A** Trocar tube, rotatable, 1 stopcock, for 160 mm telescopes, standard flow
- WA70992A** Trocar tube, rotatable, 1 stopcock, for 70 mm telescopes, standard flow
- ② **A70971A** Trocar tube, rotatable, 2 stopcocks, for 160 mm telescopes, high-flow
- WA70991A** Trocar tube, rotatable, 2 stopcocks, for 160 mm telescopes, standard flow
- WA70993A** Trocar tube, rotatable, 2 stopcocks, for 70 mm telescopes, standard flow
- ③ **A70974A** Trocar spike, triangular, for 160 mm telescopes
- A70978A** Trocar spike, triangular, for 70 mm telescopes
- ④ **A70975A** Trocar spike, blunt, for 160 mm telescopes
- A70979A** Trocar spike, blunt, for 70 mm telescopes

Spare Parts for Trocar Tubes

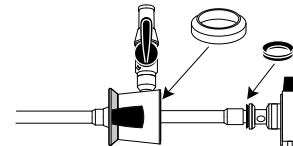

- A00507A** Sealing, set

Set of spare sealing rings:
Contains 2 large sealings (transparent) and 5 small sealings (black).

Insert Tray for Arthroscopy

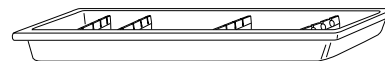

- A05951A** Insert tray, for TrueView II

TrueView II

System Chart

System Chart

