

OLYMPUS

Your Vision, Our Future

UROLOGY

**Pediatric Urology
System**

OES Pro

Small Instruments That Feel Just Great



OES PRO PEDIATRIC UROLO

CYSTOSCOPE SYSTEM

- ✓ Maintenance-free stopcocks
- ✓ Albarran for exact control
- ✓ 0° and 30° telescopes
- ✓ Stainless steel

COMPACT CYSTOSCOPE

- ✓ Straight ocular
- ✓ Compact slim design
- ✓ Integrated stopcocks
- ✓ Oval channel design
- ✓ Excellent flow characteristics
- ✓ Stainless steel

OPTICAL URETHROTOME

- ✓ Combined working element for optical urethrotome and resectoscope
- ✓ Small outer diameter
- ✓ Ergonomic design
- ✓ Stainless steel



GY. THE COMPLETE SYSTEM.

COMPACT CYSTOSCOPE



- ✓ Straight channel
- ✓ Compact slim design
- ✓ Integrated stopcocks
- ✓ Oval channel design
- ✓ Excellent flow characteristics
- ✓ Stainless steel



- ✓ Single and continuous flow system
- ✓ Fixed 15 Fr. sheath
- ✓ Large 7.5 Fr. oval channel
- ✓ Pediatric and adult mini-nephroscope
- ✓ Stainless steel







RESECTOSCOPE

- ✓ Small outer diameter
- ✓ Ergonomic design
- ✓ Direct HF connection
- ✓ Automatic locking mechanism
- ✓ Atraumatic insulation beak
- ✓ Stainless steel



PERCUTANEOUS NEPHROSCOPE

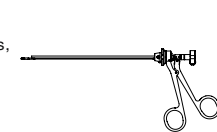

Cystoscope System

A3764A A3765A	Telescope, 1.9 mm, 0° direction of view 30° direction of view	
A37000A	Cystoscope sheath, 7.9 Fr.	
A37001A	Cystoscope sheath, 9.5 Fr., 3 Fr. channel	
A37002A	Cystoscope sheath, 10.8 Fr., 5 Fr. channel	
A37003A	Cystoscope sheath, 13 Fr.	
A37005A	Working insert, Albarran, one way, for A37003A, 4 Fr. channel	
A37006A	Grasping forceps, optical, for A37003A	



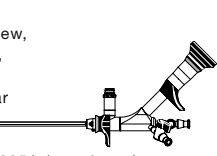

Compact Cystoscope

A37027A	Compact cystoscope, 7° direction of view, 7.9 Fr. x 160 mm, 4.2 Fr. channel, straight ocular	
A37026A	Compact cystoscope, 7° direction of view, 7.9 Fr. x 160 mm, 4.2 Fr. channel, 45° angled ocular	
A37025A	OP telescope, 7° direction of view, 11 Fr. x 220 mm, 7.5 Fr. channel, 45° angled ocular	
WA37025B	Adapter, for A37025A (not shown), for usage as compact cystoscope	

Light-Guide Cable

A03200A	Light-guide cable, 3 mm diameter, plug type	
---------	---	---

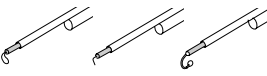
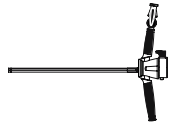
Resectoscope

A3764A	Telescope, 1.9 mm, 0° direction of view	
A37014A	Working element, for resectoscope, and optical urethrotome	
A37011A A37012A A37013A	HF-resection electrodes, sterile, single use, for A37014A, loop needle hook	
A37004A	Sheath, 10 Fr., for resectoscope	
A00010A A00011A A00012A	HF-cable, 4 m, for Olympus HF-unit for Martin, Erbe, and Berchthold HF-unit for Valleylab HF-unit	



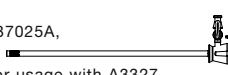
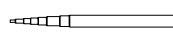

Percutaneous Nephroscope

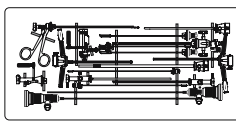
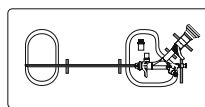
A37025A	OP telescope, 7° direction of view, 11 Fr. x 220 mm, 7.5 Fr. channel, angled ocular	
A37022A	Outer sheath, 15.9 Fr. for A37025A, fixed, incl. sheath for usage with A3327	
A3327	Bougie tube, set, 9-27 Fr.	



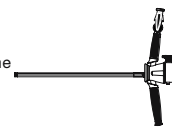

Instrument Tray

WA05995A	Insert tray, for pediatric urology	
Part of delivery of A37025A-27A.		
A05961A	Insert tray, for compact cystoscope	

Optical Urethrotome

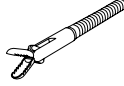
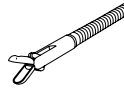
A3764A	Telescope, 1.9 mm, 0° direction of view	
A37007A	Bridge, one way, 3 Fr. channel	
A37014A	Working element, for resectoscope and optical urethrotome	
A37008A A37009A A37010A	Knife, sterile, single use, for A37014A, round hook straight	
A37028A	Sheath, 9.5 Fr., for optical urethrotome	

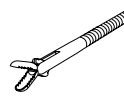
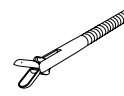
Endo-Therapy Instruments

A37015A	Grasping forceps, 5 Fr. x 340 mm, semi-flexible	
A37016A	Biopsy forceps, 5 Fr. x 340 mm, semi-flexible	
A37017A	Grasping forceps, 3-nail, 5 Fr. x 340 mm, semi-flexible	
A37018A	Grasping forceps, 3 Fr. x 280 mm, flexible	
A37019A	Biopsy forceps, 3 Fr. x 280 mm, flexible	
A37020A	HF-electrode, button, 3 Fr. x 370 mm, flexible	
A0130.2 O0120.1 A0335.1	HF-cable, unipolar, 3.5 m, for Olympus HF-unit for Martin and Erbe HF-unit for Valleylab HF-unit	

OLYMPUS

Manufactured by
OLYMPUS WINTER & IBE GMBH

Distributed by
OLYMPUS MEDICAL SYSTEMS CORPORATION
OLYMPUS MEDICAL SYSTEMS EUROPA GMBH
OLYMPUS SURGICAL & INDUSTRIAL AMERICA INC.
OLYMPUS AMERICA INC.
OLYMPUS KEYMED GROUP LTD.
OLYMPUS SINGAPORE PTE LTD.
OLYMPUS MOSCOW LIMITED LIABILITY COMPANY
OLYMPUS AUSTRALIA PTY. LTD.
OLYMPUS LATIN AMERICA INC.
OLYMPUS (BEIJING) SALES & SERVICE, CO., LTD.

Kuehnstraße 61, 22045 Hamburg, Germany

2951 Ishikawa-cho, Hachioji-shi, Tokyo 192-8507, Japan
Wendenstraße 14-18, 20097 Hamburg, Germany
One Corporate Drive, Orangeburg, New York 10962, U.S.A.
Two Corporate Center Drive, Melville, N.Y. 11747-3157, U.S.A.
KeyMed House, Stock Road, Southend-on-Sea, Essex SS2 5QH, United Kingdom
491B, River Valley Road #12-01/04, Valley Point Office Tower, Singapore 248373
117071, Moscow, Malaya Kaluzhskaya 19, bld. 1, fl.2, Russia
31 Gilby Road, Mount Waverley VIC 3149, Australia
6100 Blue Lagoon Drive, Suite 390 Miami, FL 33126-2087, U.S.A.
13F - 14F, East Tower, Gongyuan No. 6 Royal Palace, No. 6 GongyuanXijie,
Jianguomennei, Dongcheng District, Beijing, 100005, China